



Harry Potter



4840



1

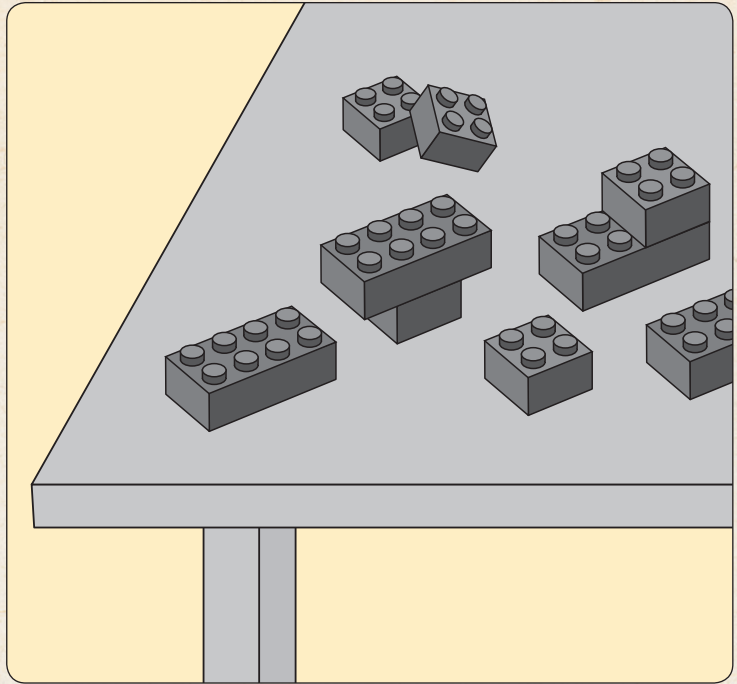
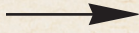
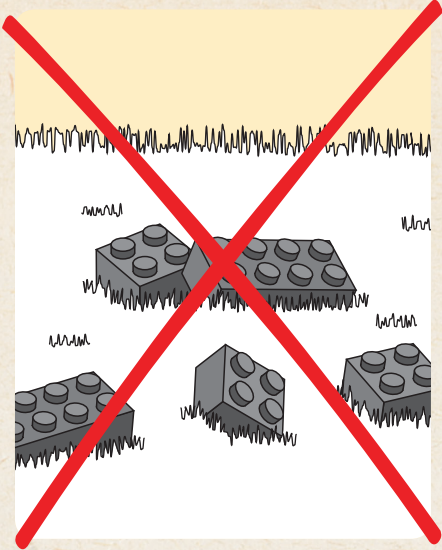

2



2

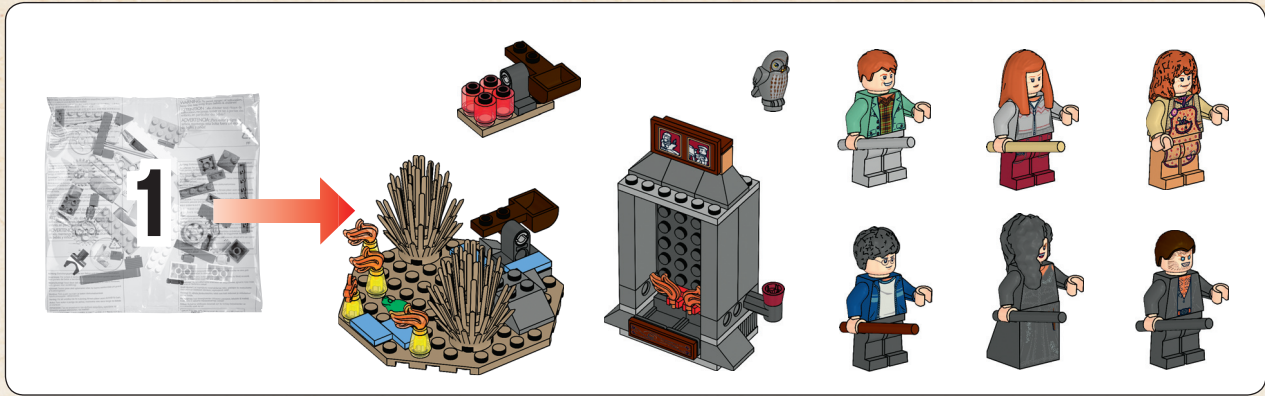

3

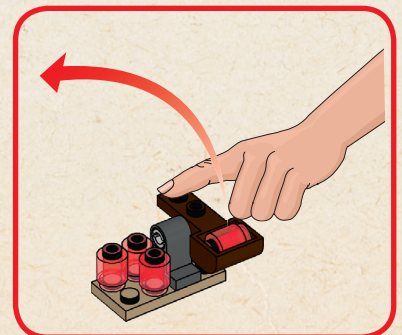
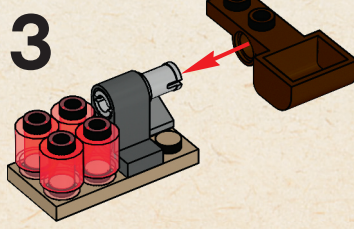
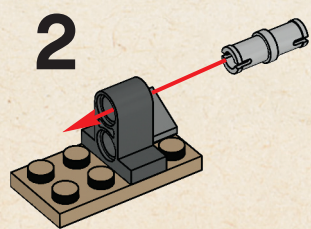
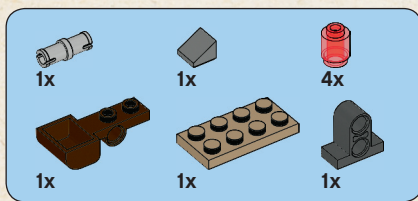
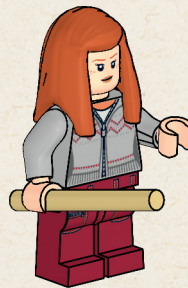
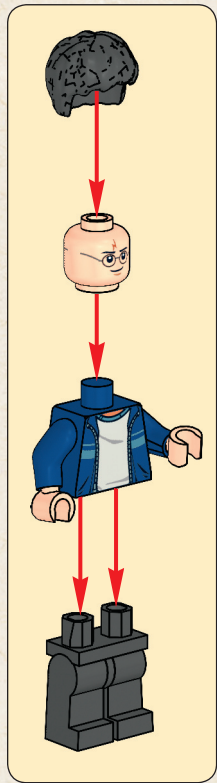

3

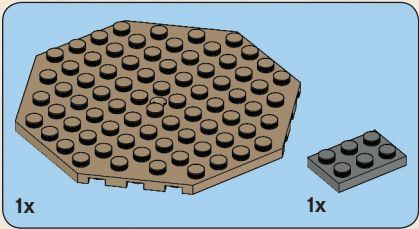
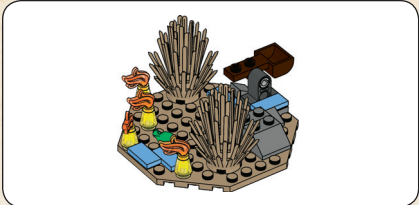

1

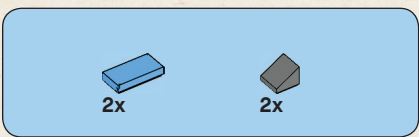
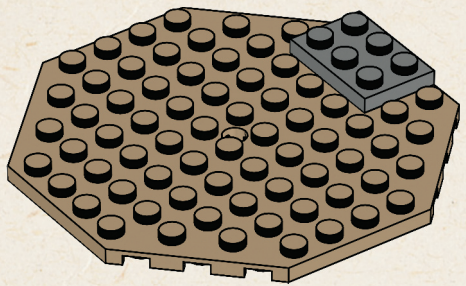

2

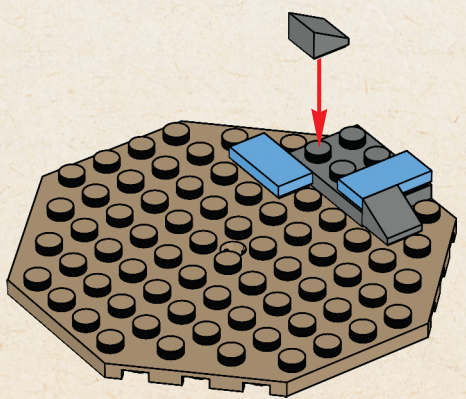

4

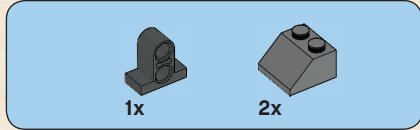

3

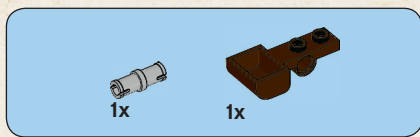
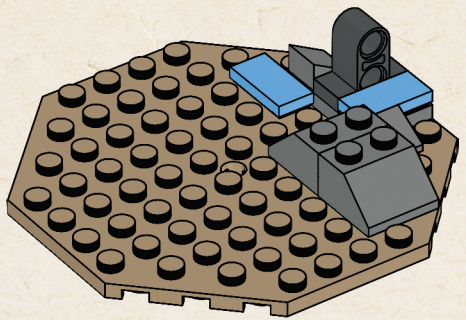

4

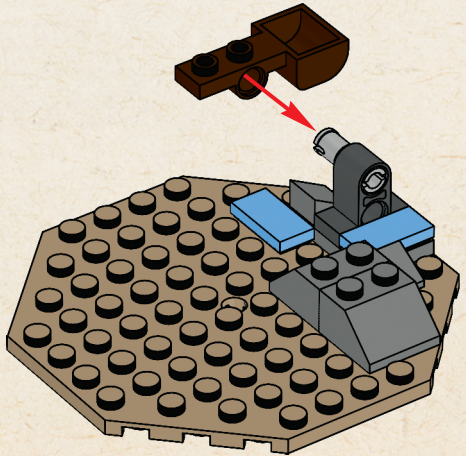

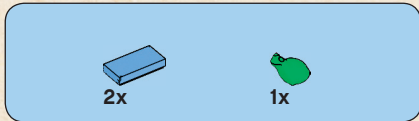

5

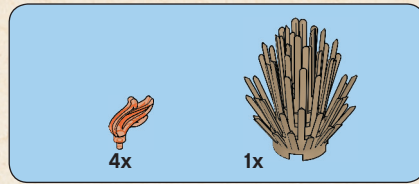
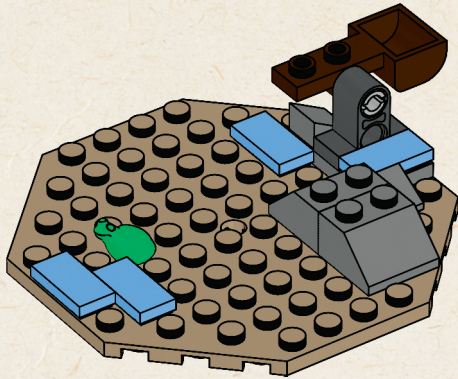

7

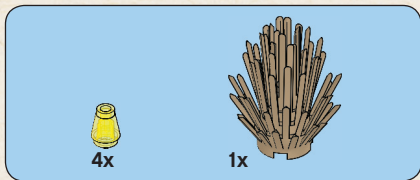

6

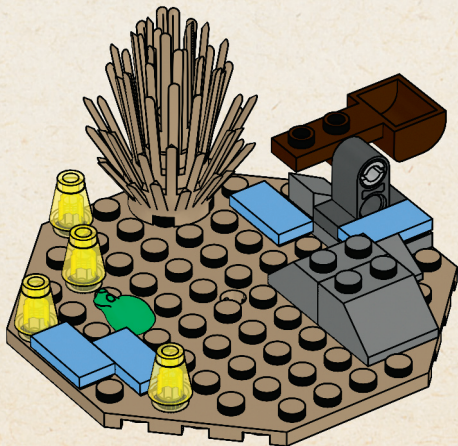

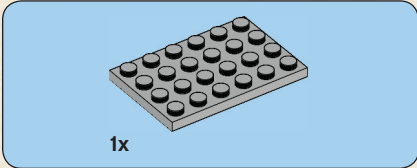
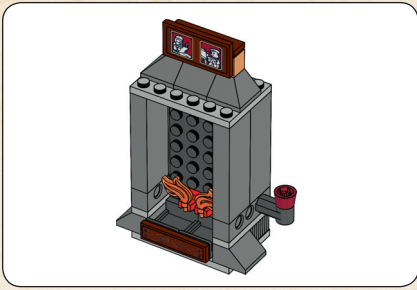

1

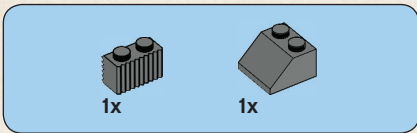
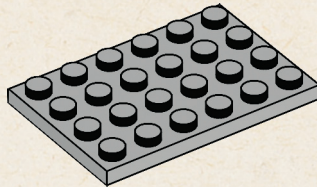

2

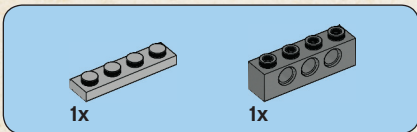
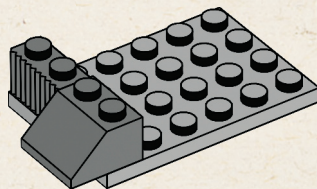

3

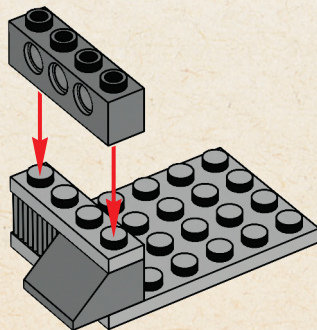

6

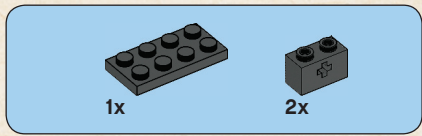
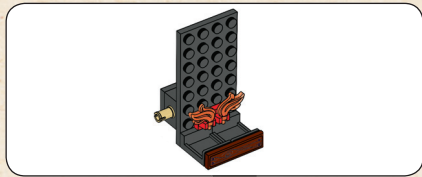

1

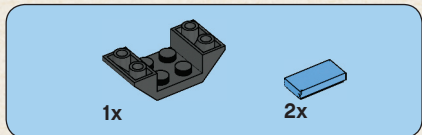
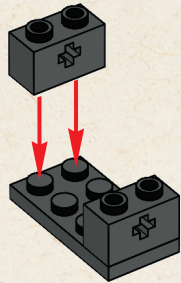

2

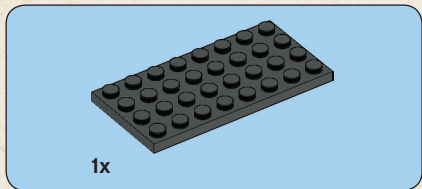
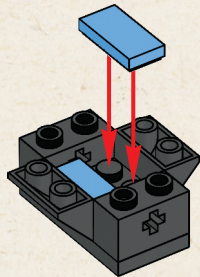

3

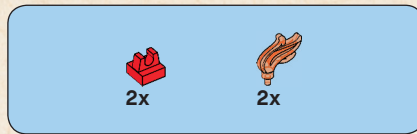
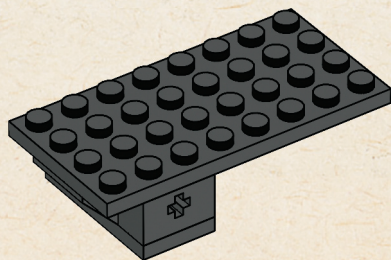

4

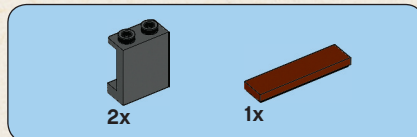
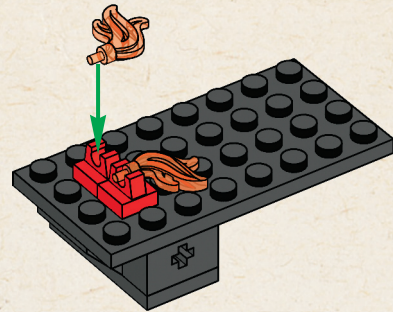

5

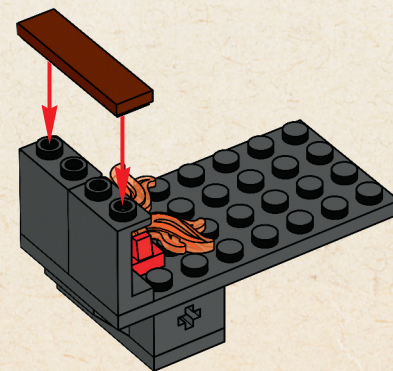

6

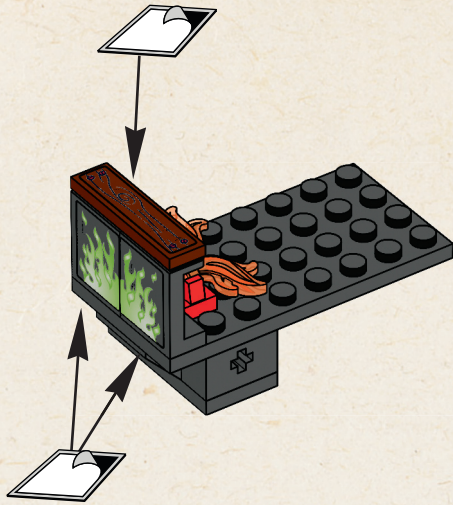

7

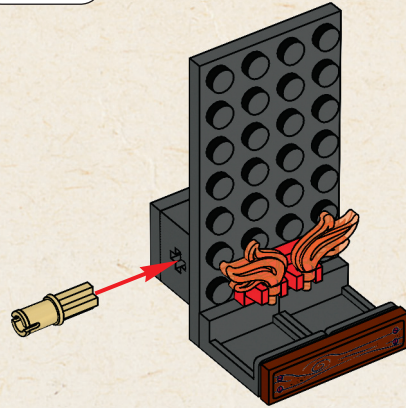
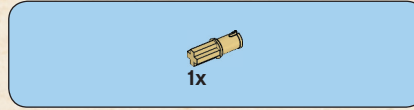

4

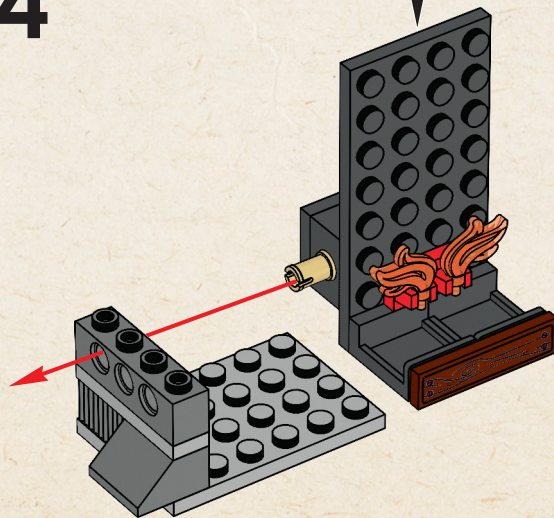

8

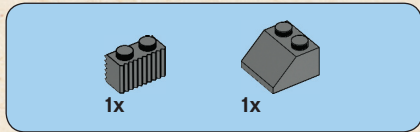

5

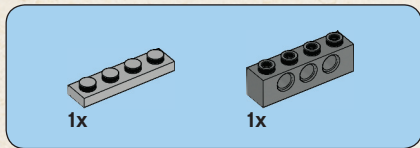
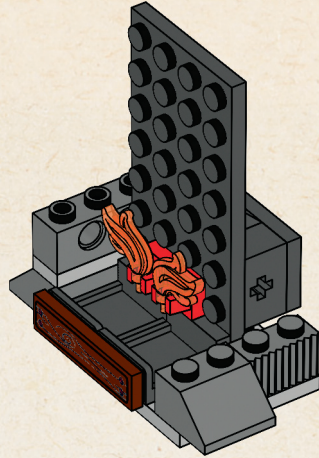
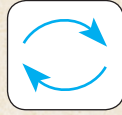

6

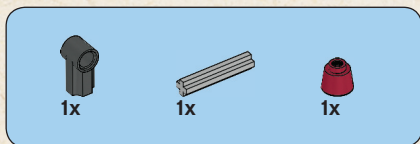
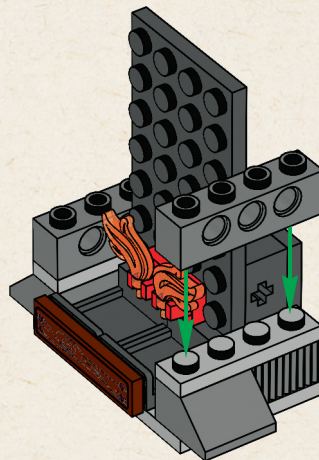

7

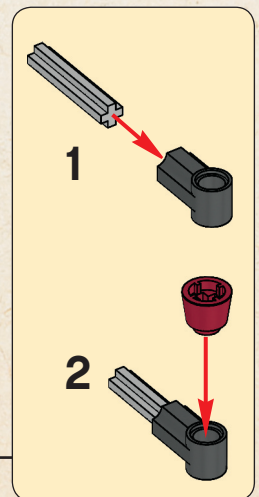
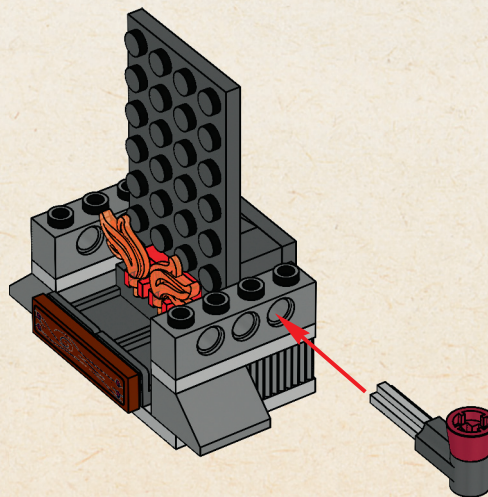

9

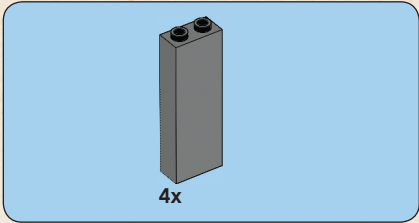

8

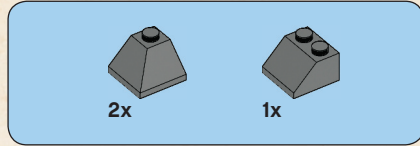
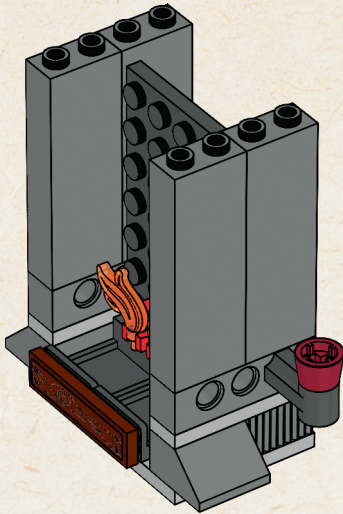

10

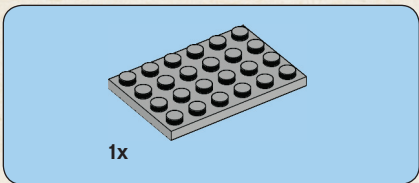
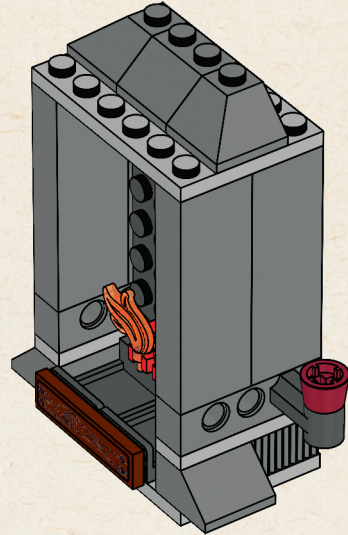

9

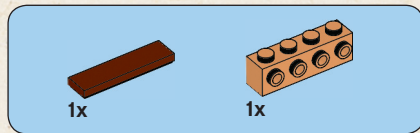
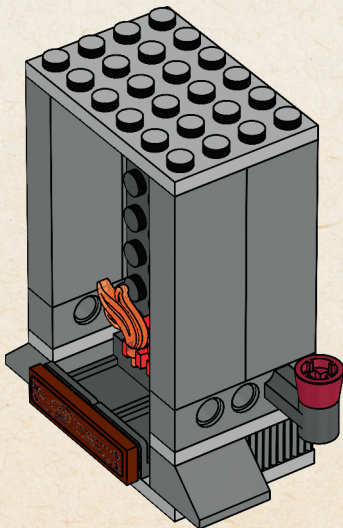

11

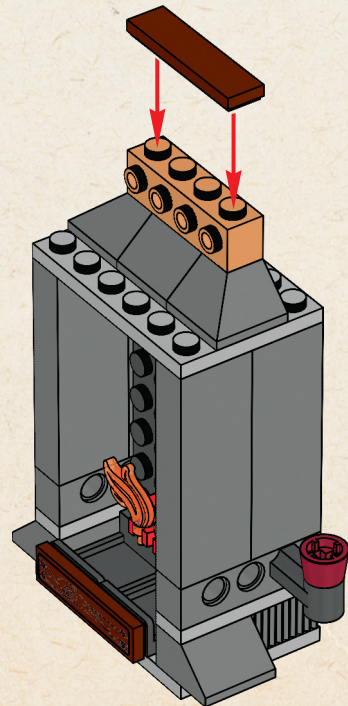

10

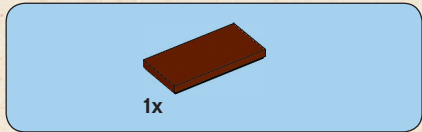

12

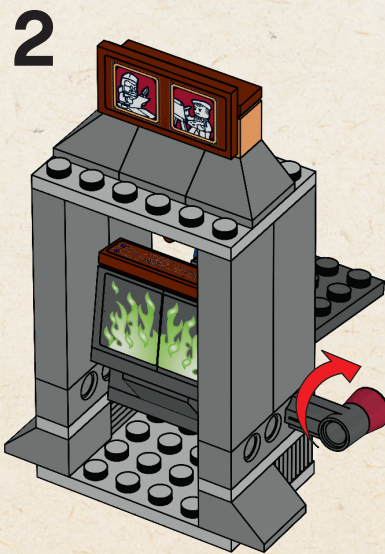
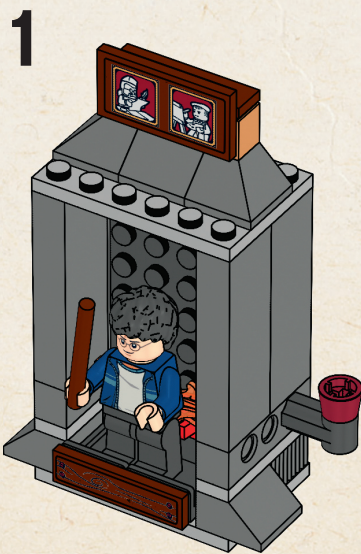
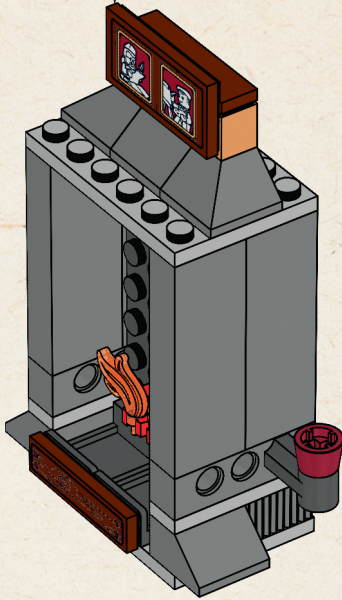
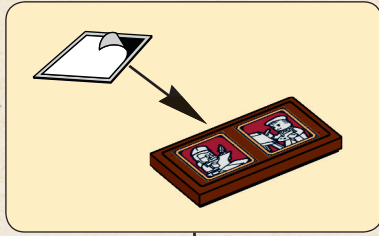

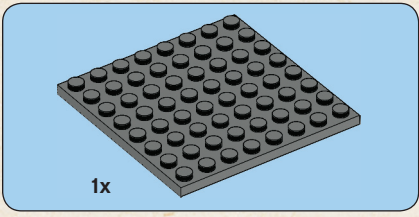
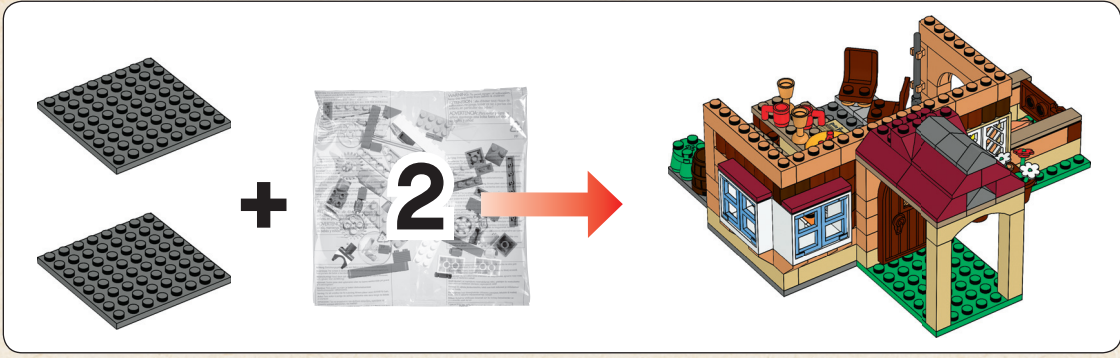

1

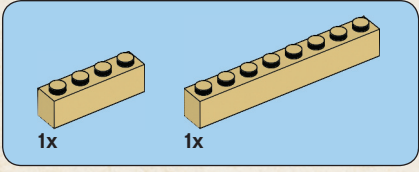
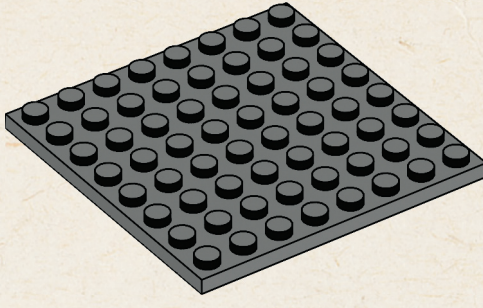

2

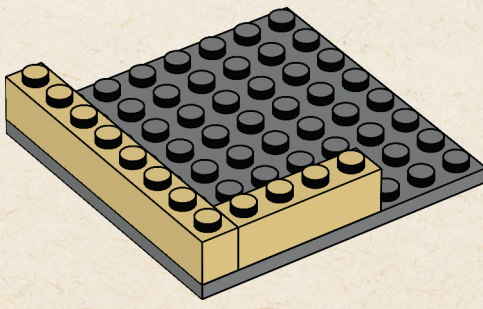

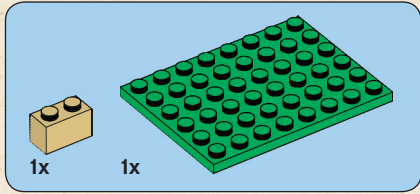

3

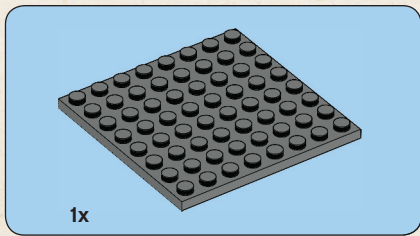
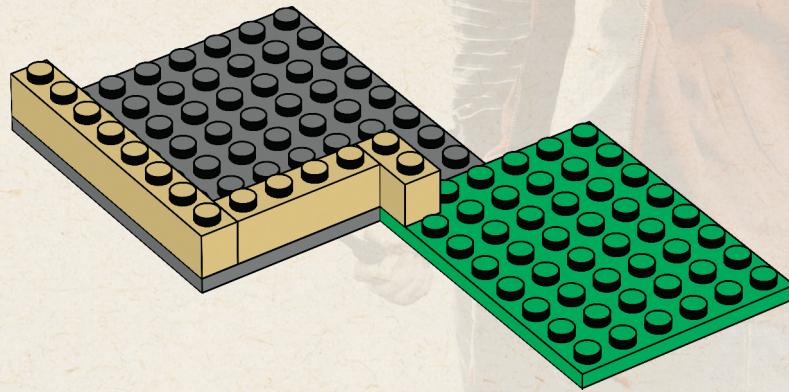

4

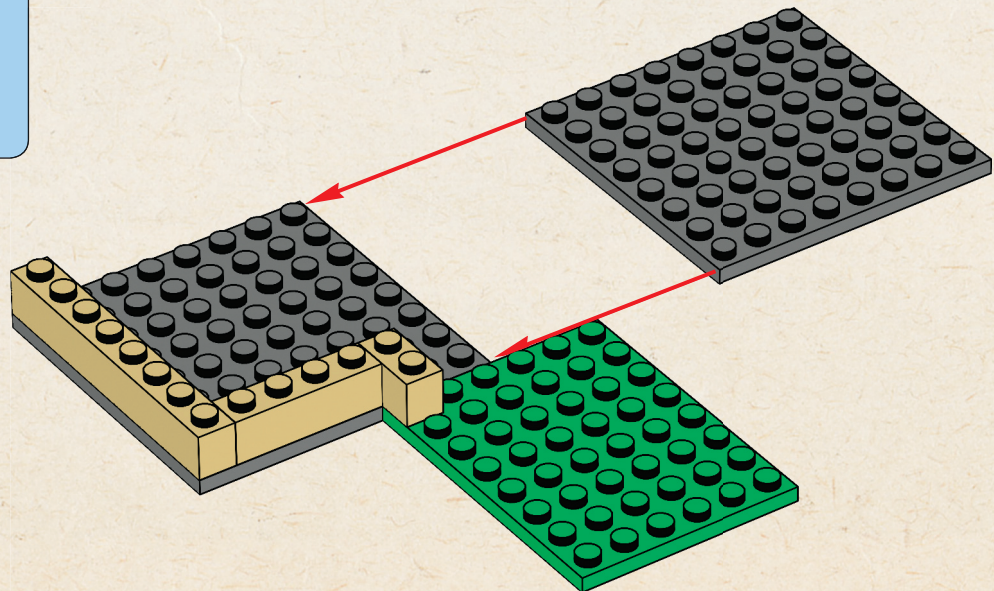

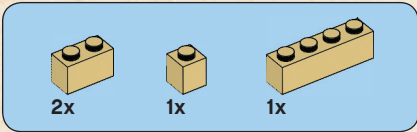

5

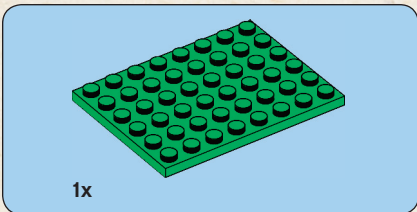
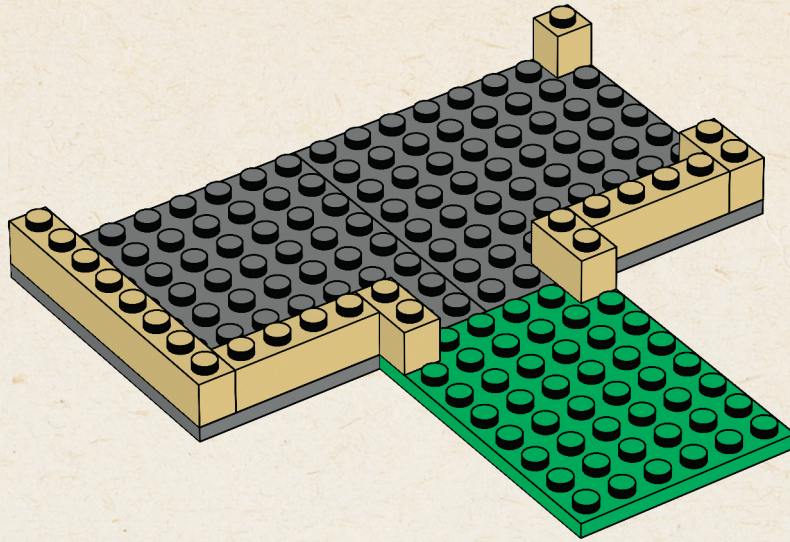

6

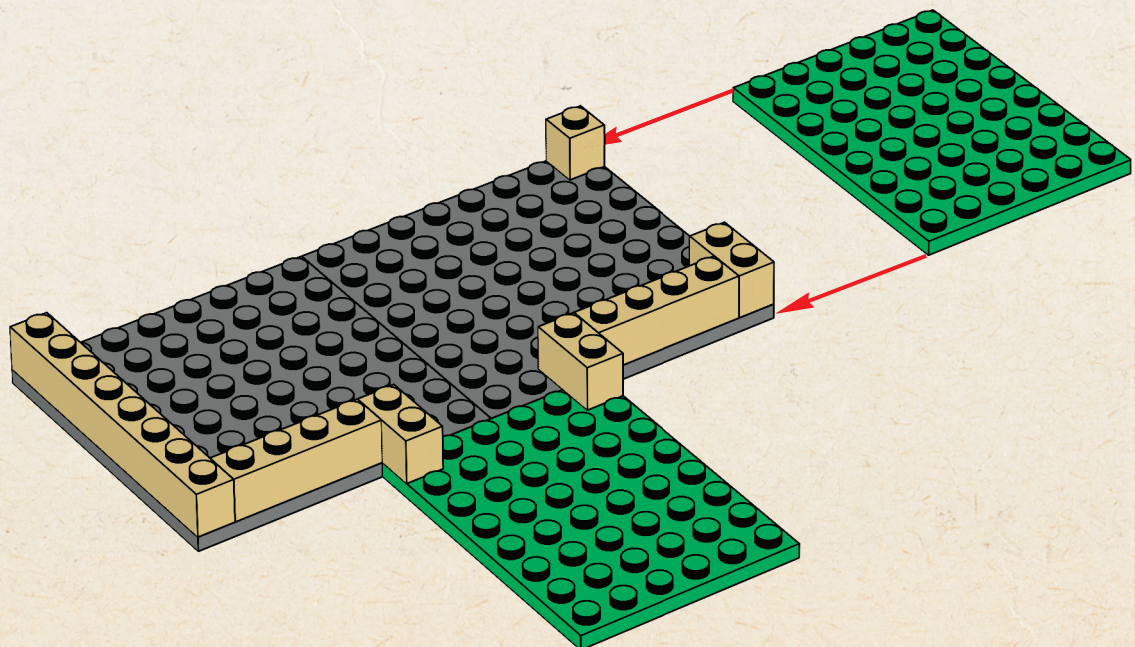

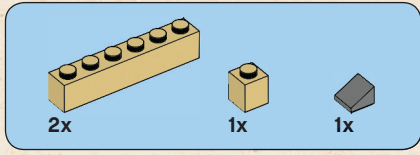

7

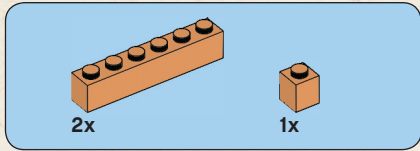
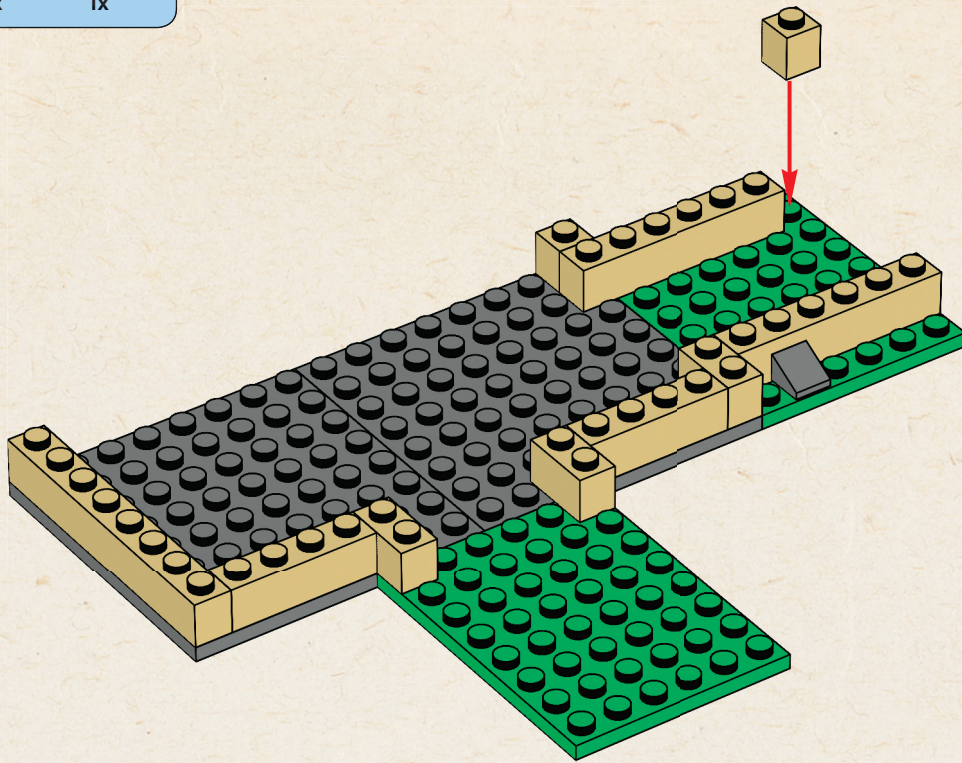

8

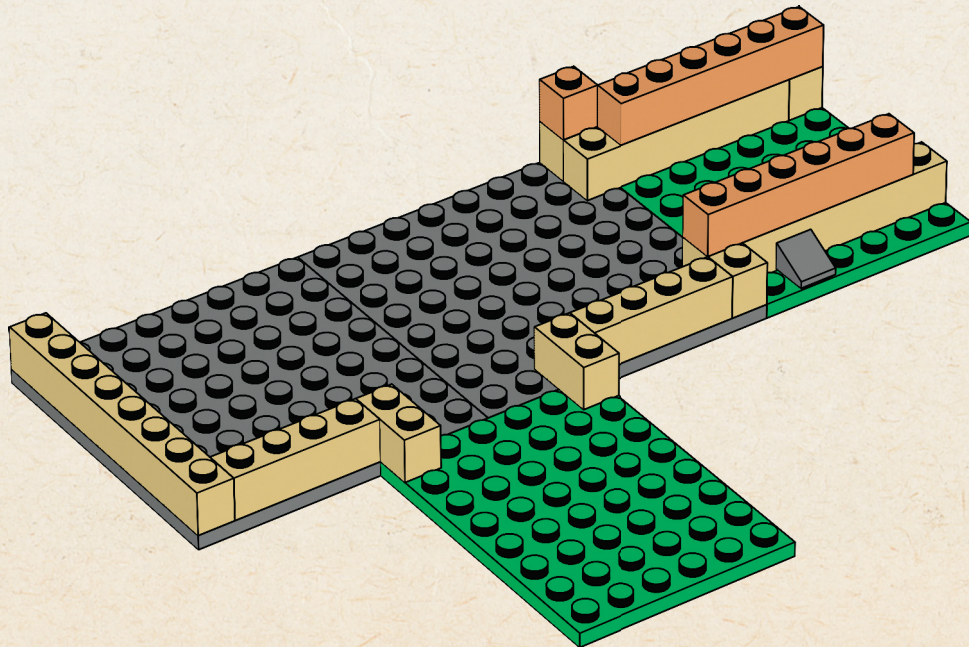

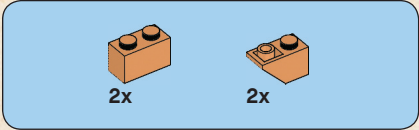

9

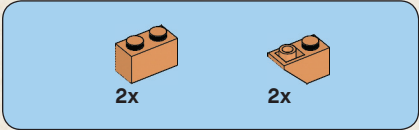
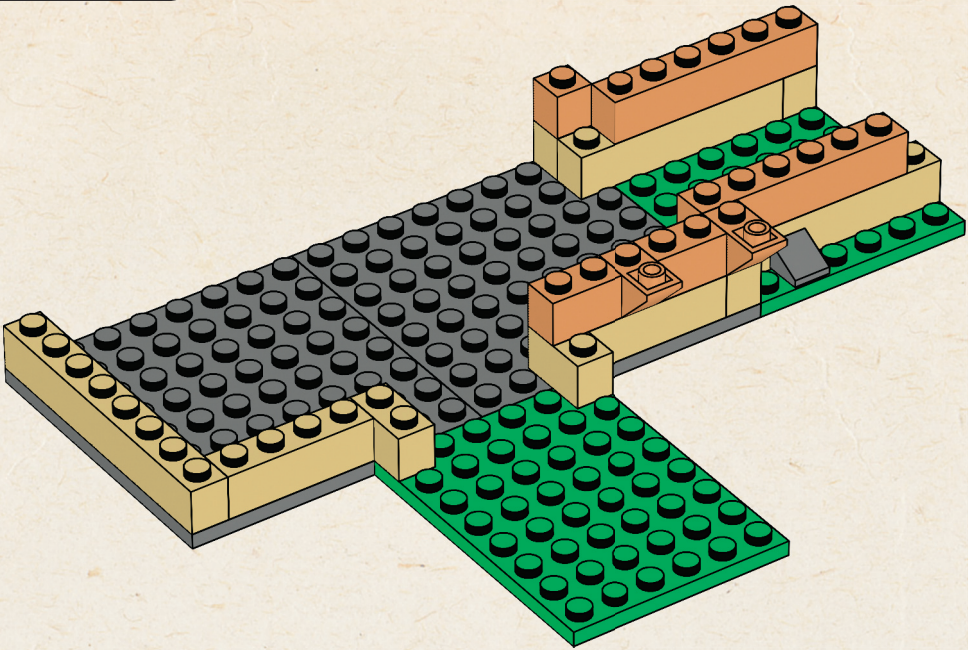

10

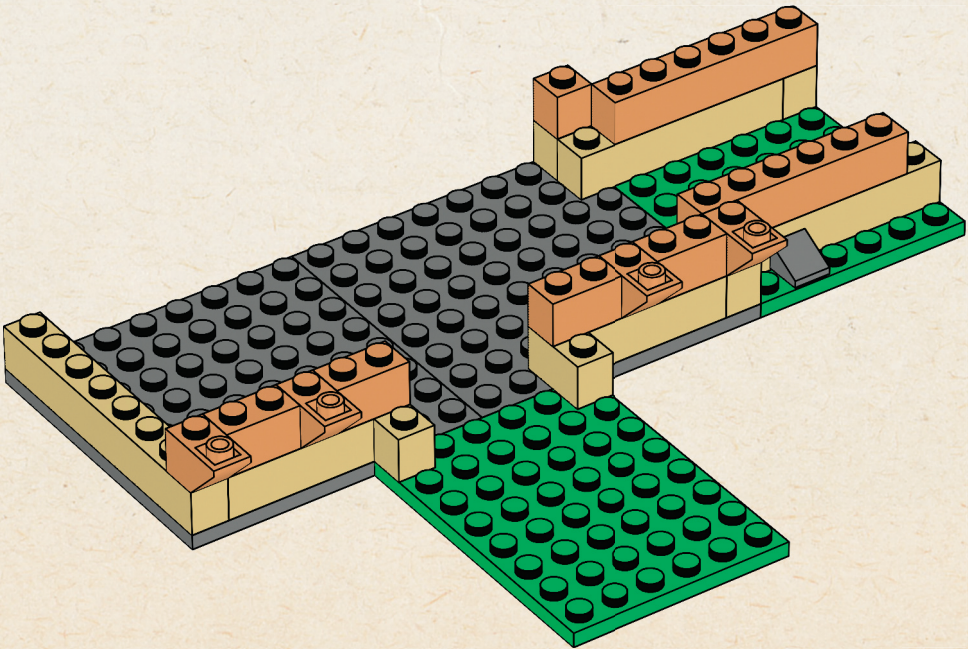

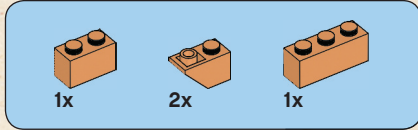

11

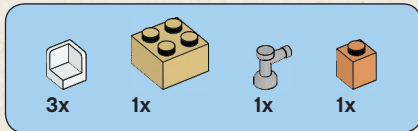
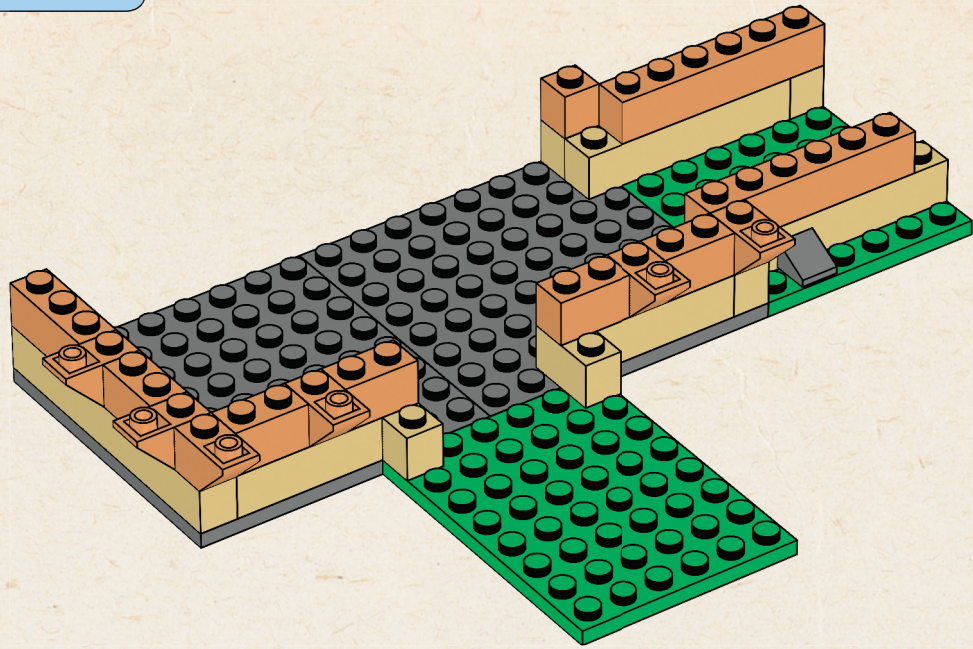

12

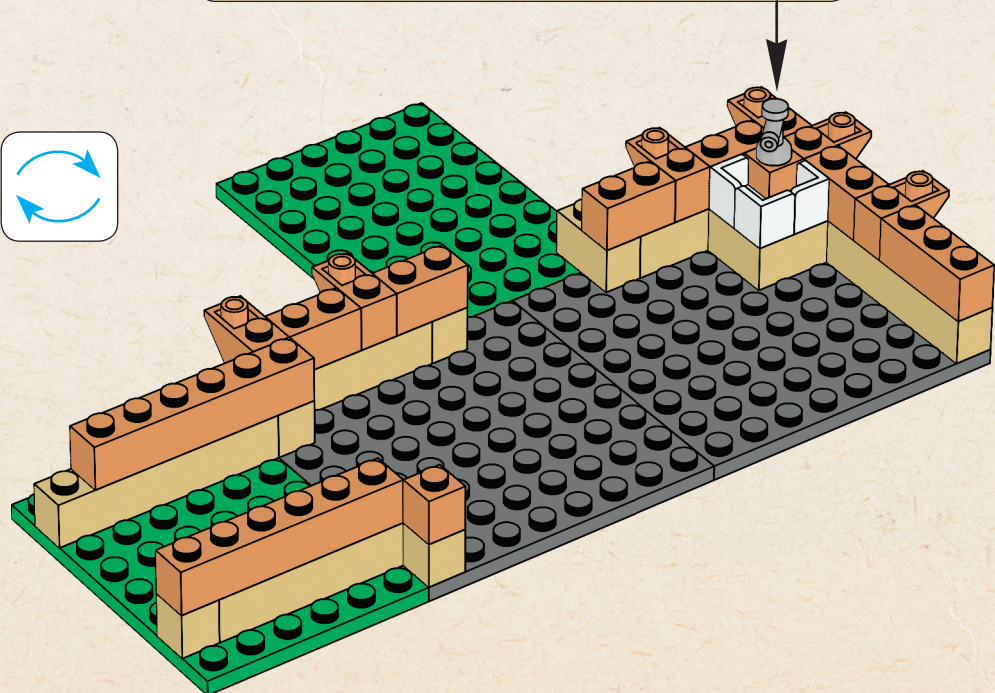
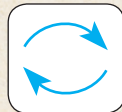
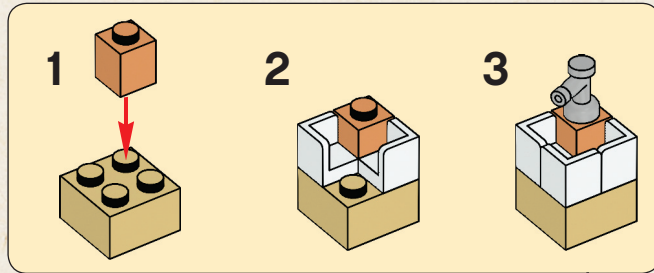

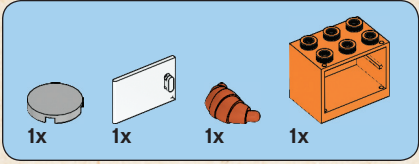

13

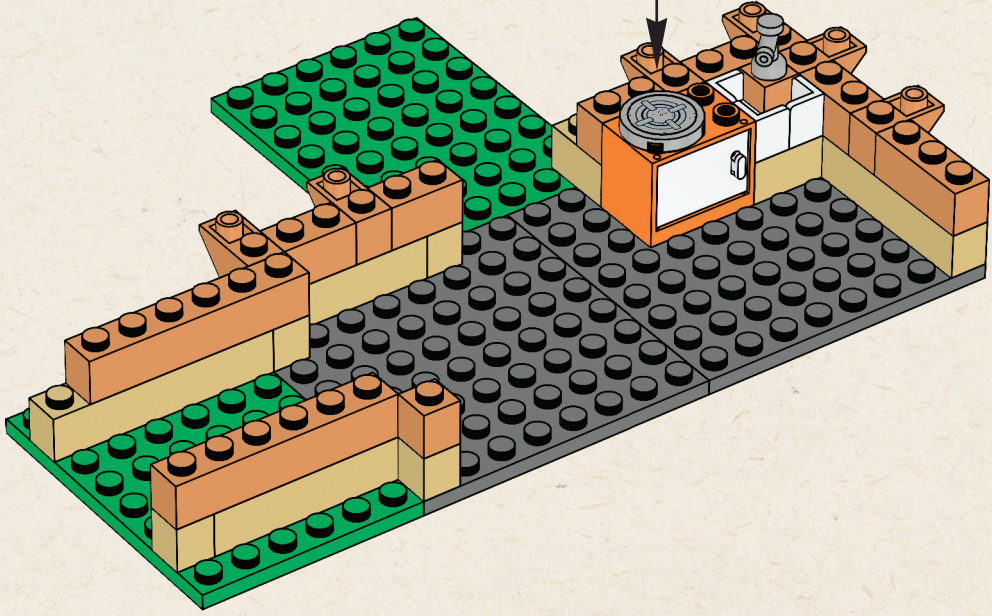
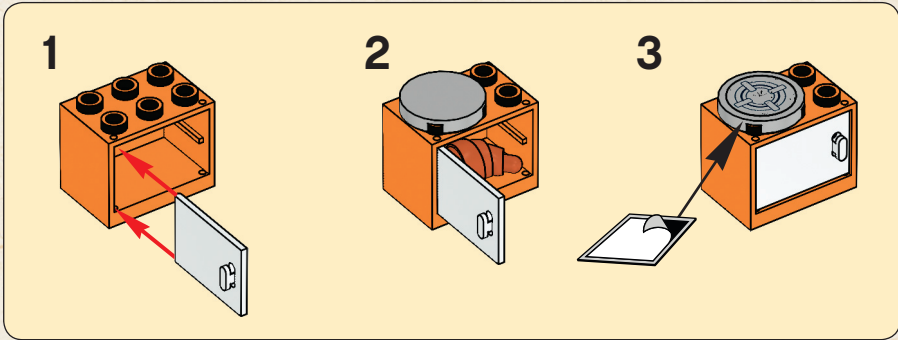

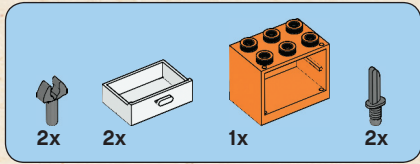

14

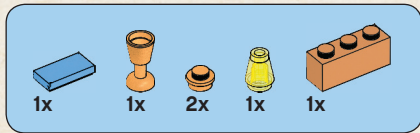
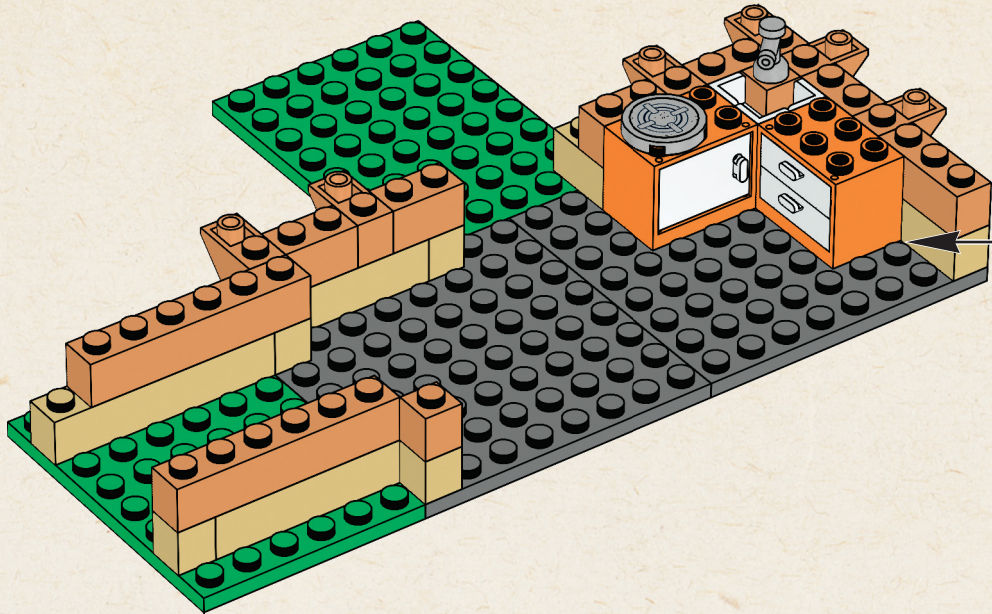
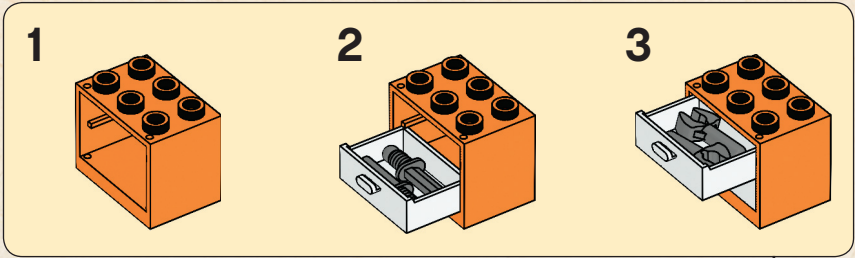

15

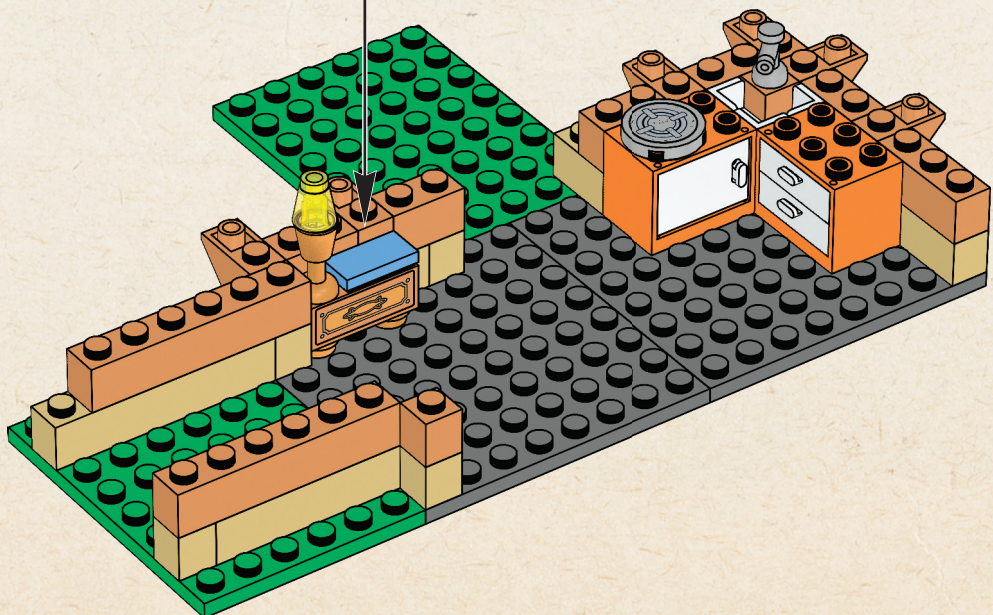
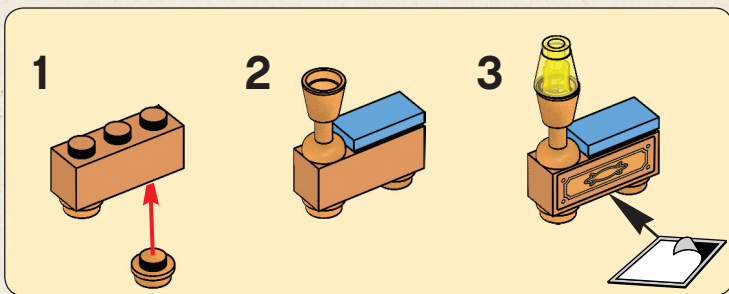

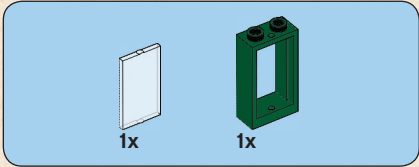

16

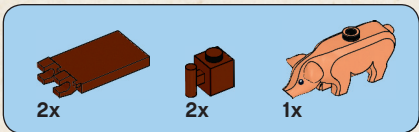
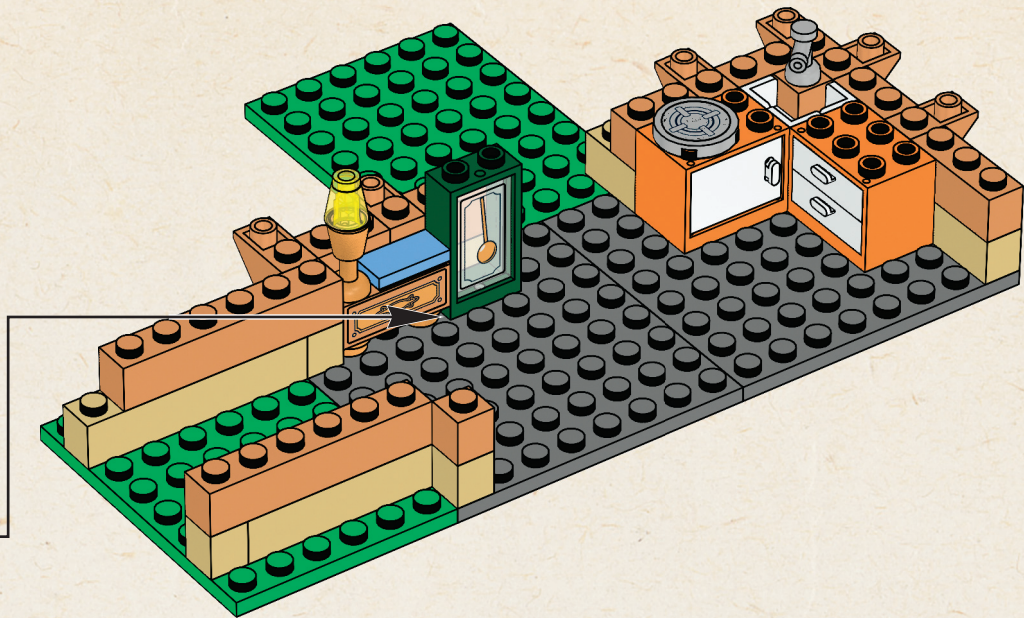
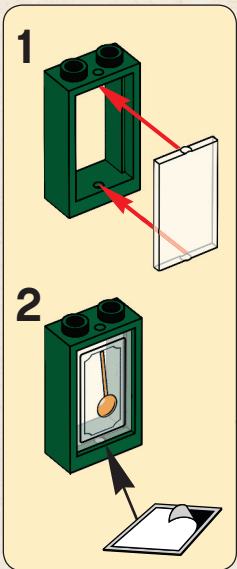

17

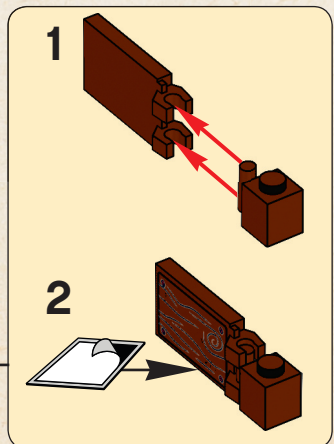
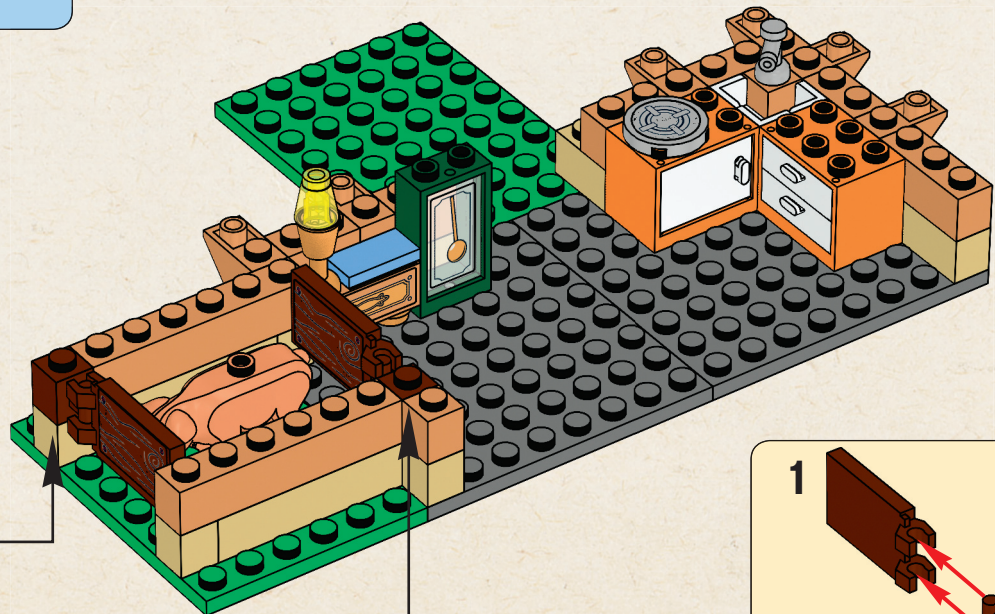
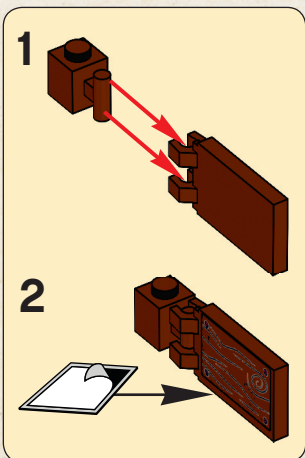

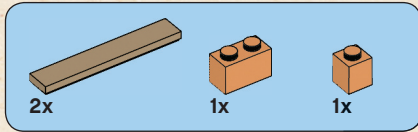

18

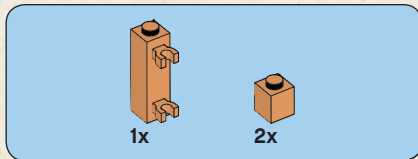
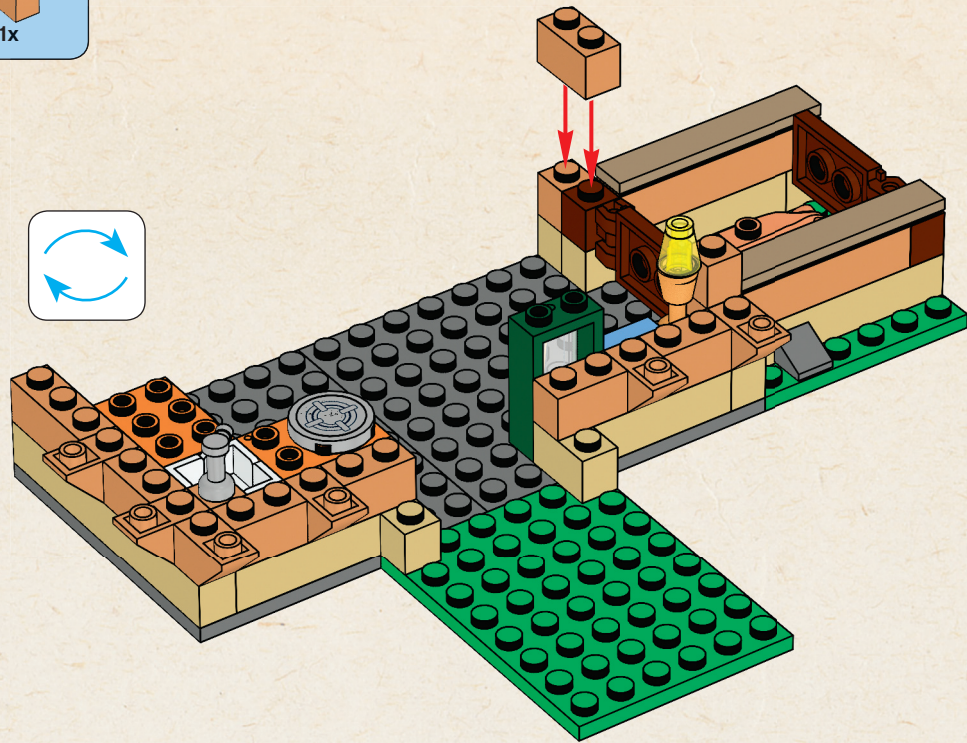
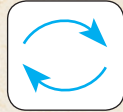

19

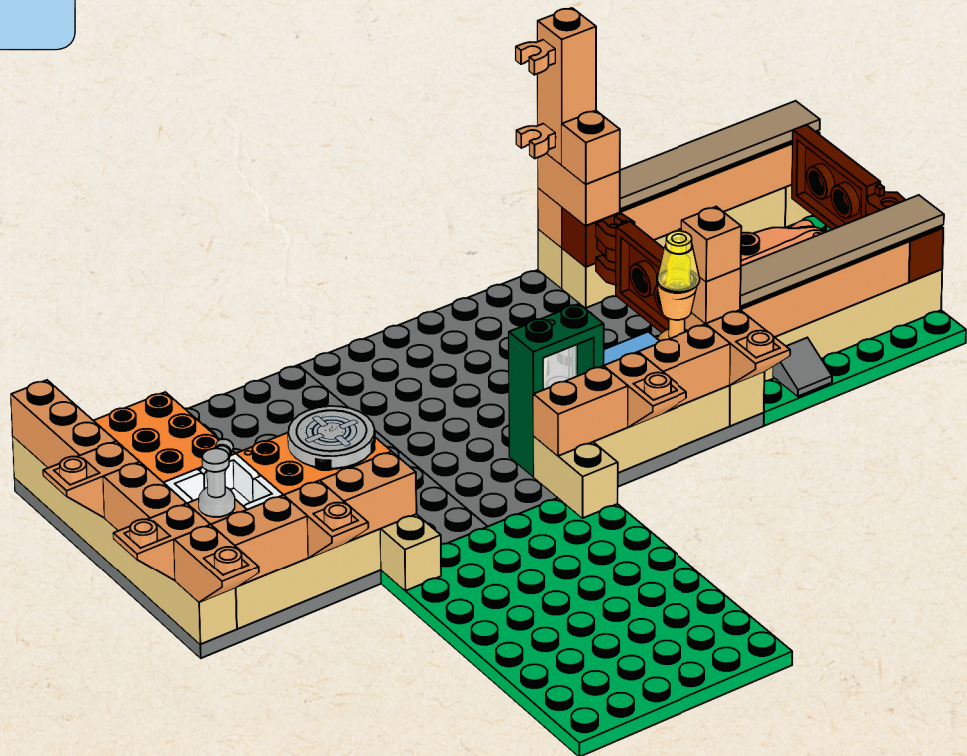

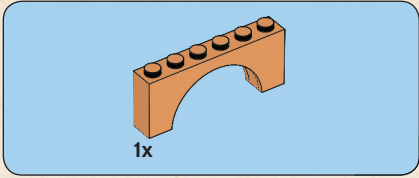

20

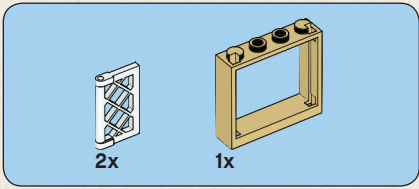
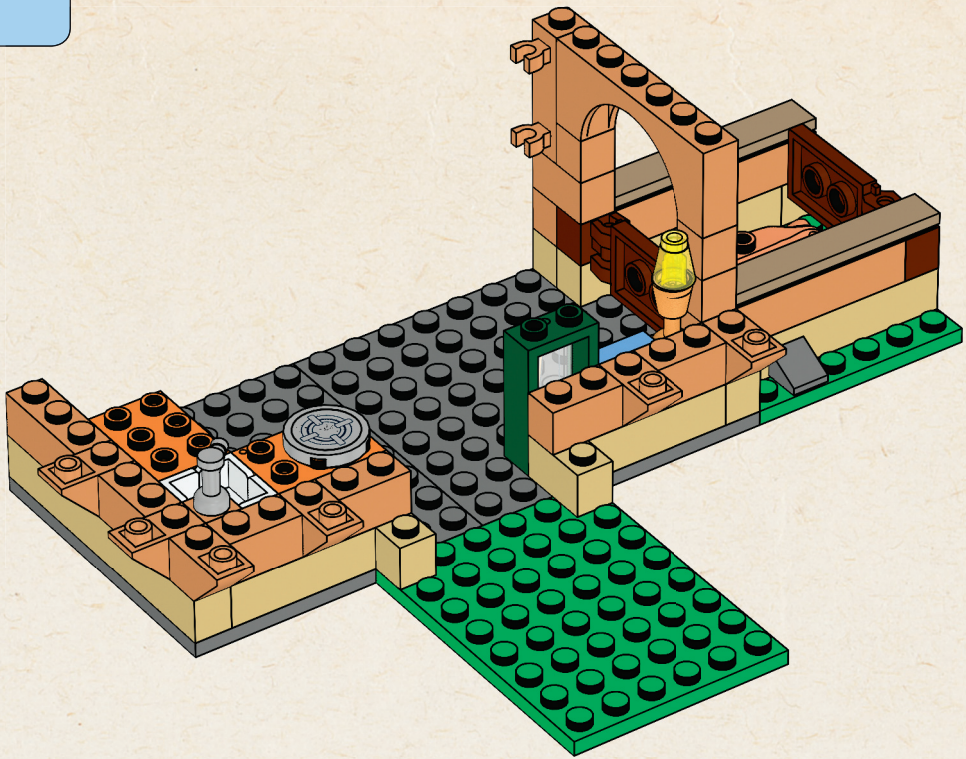

21

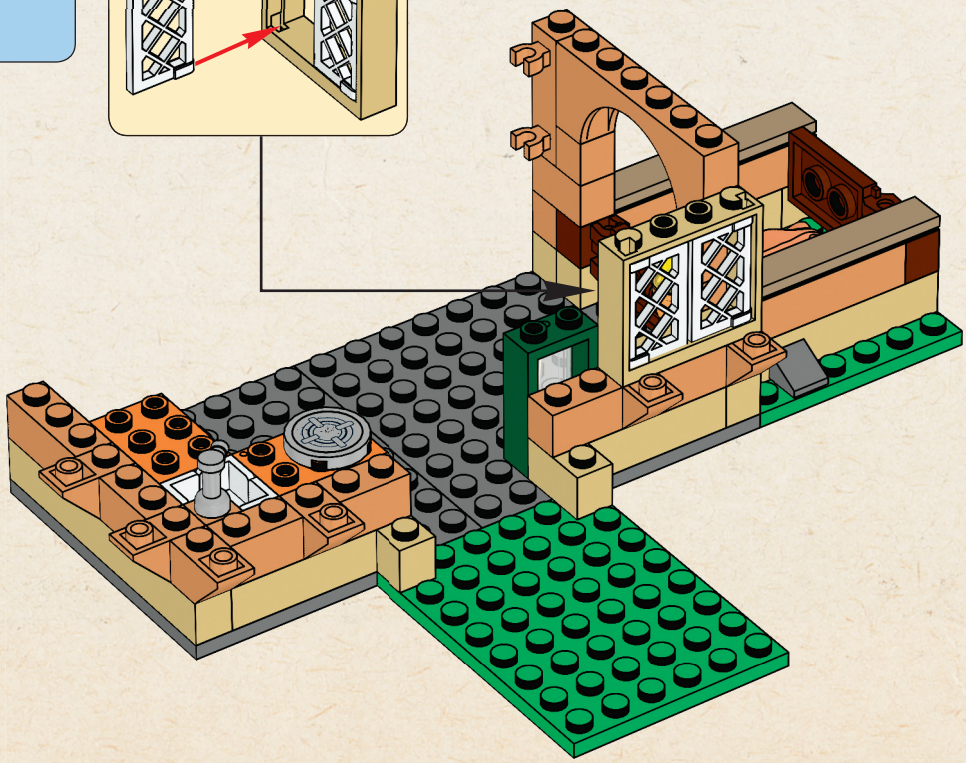
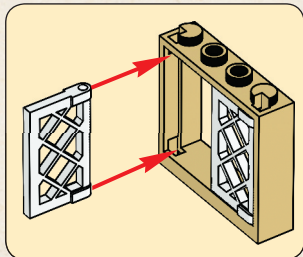

22

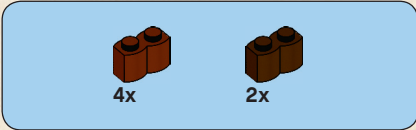

22

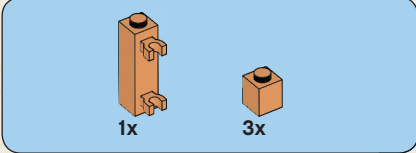
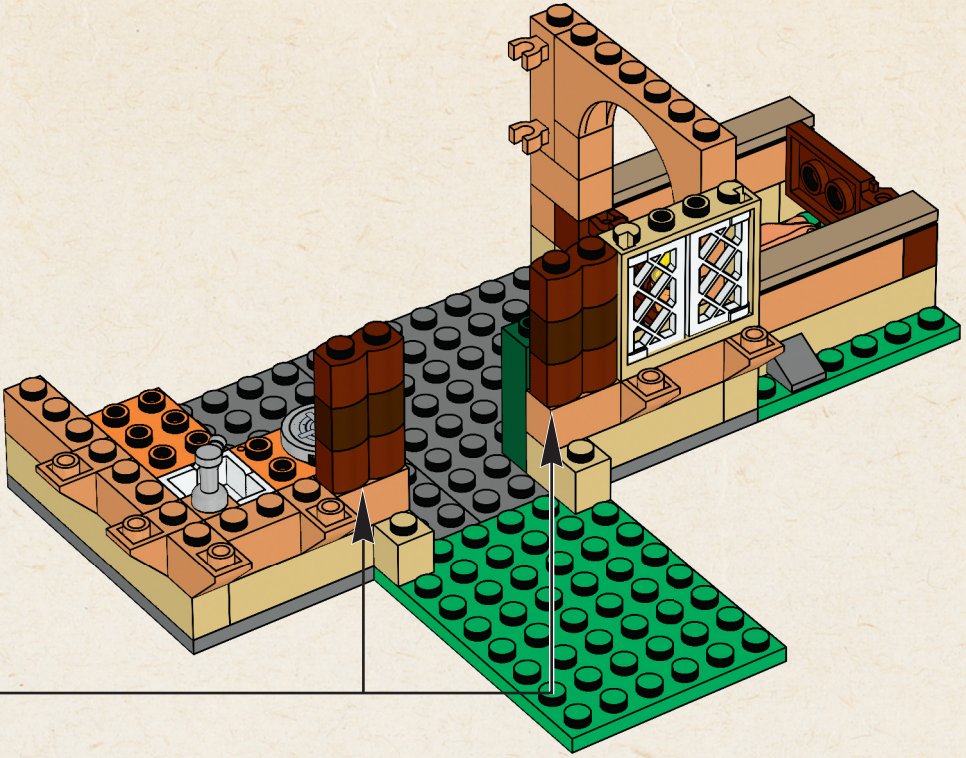
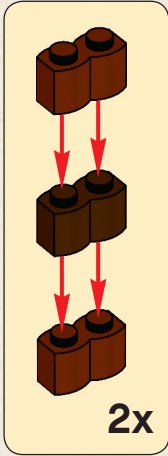

23

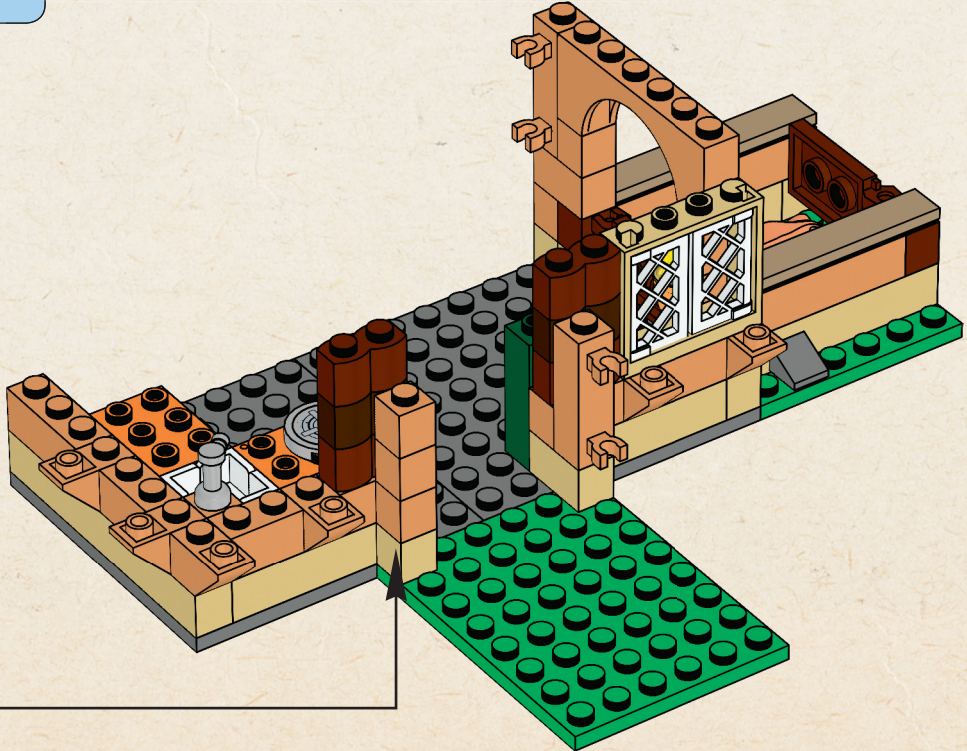
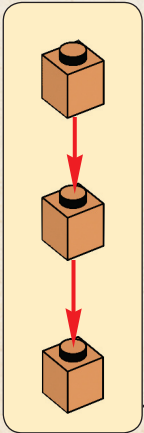

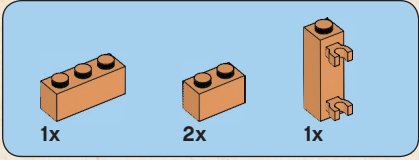

24

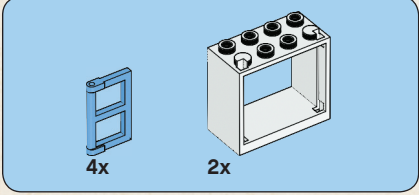
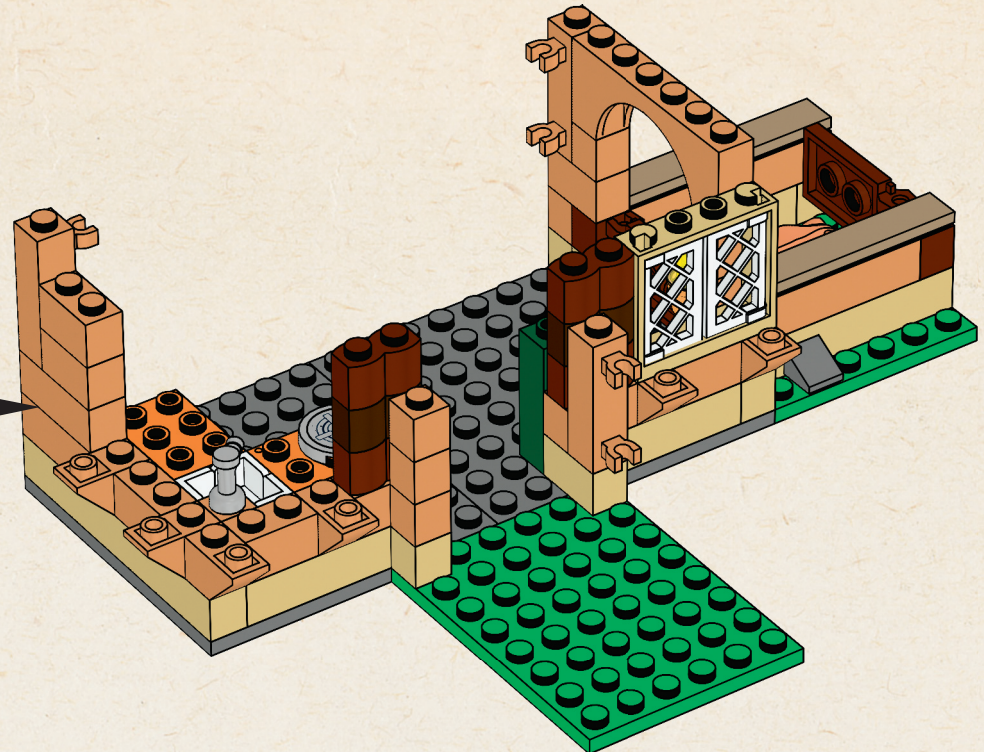
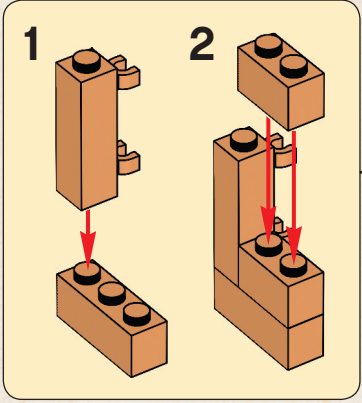

25

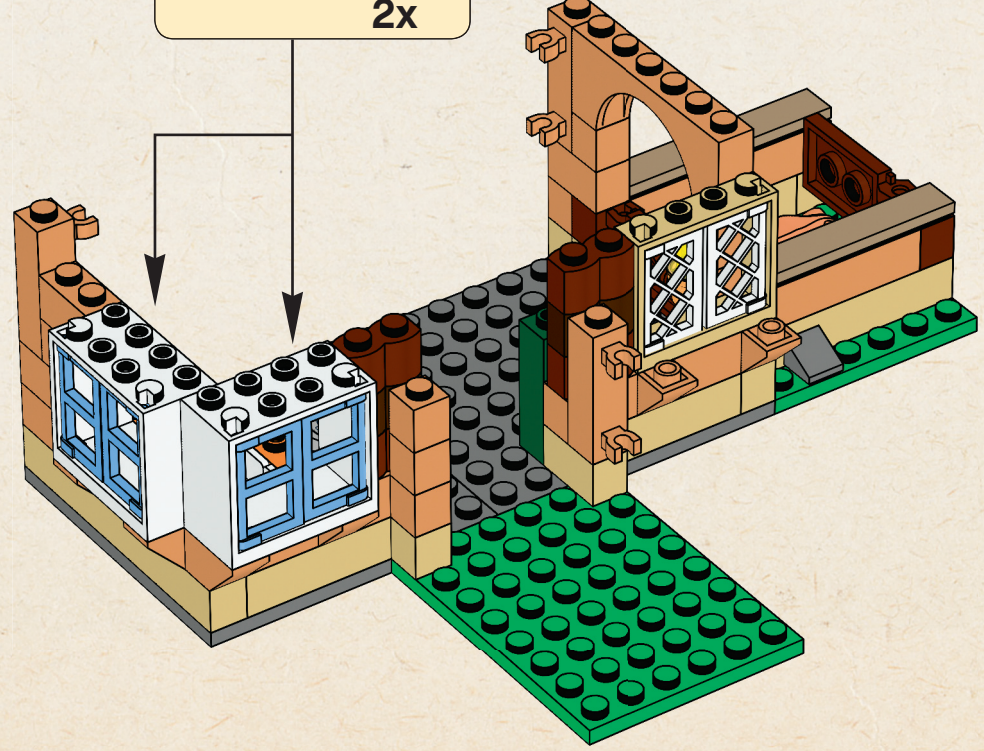
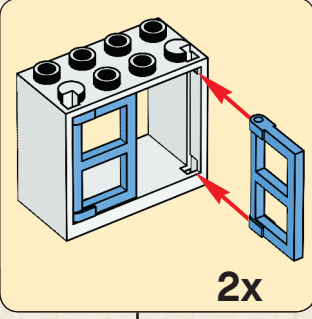

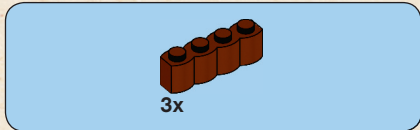

26

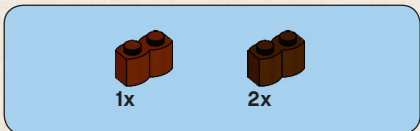
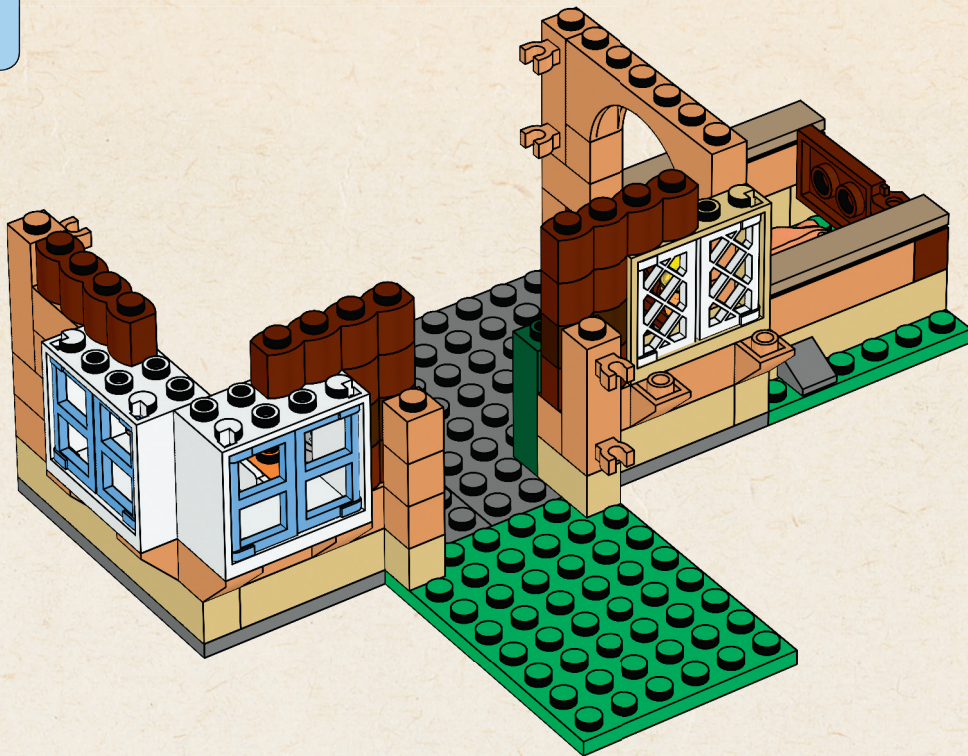

27

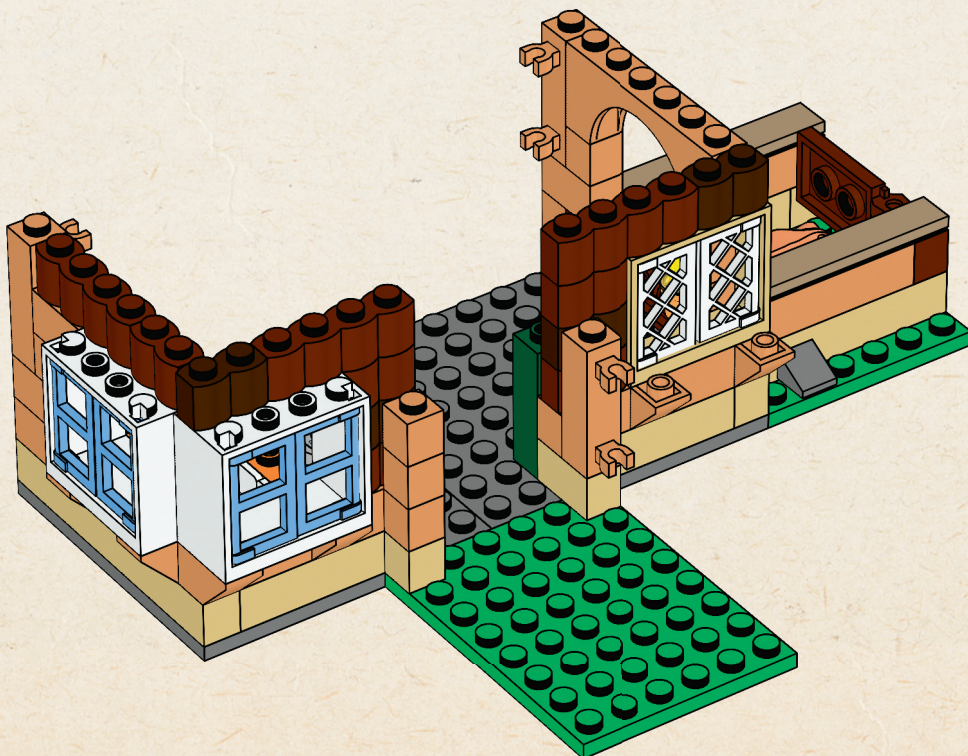

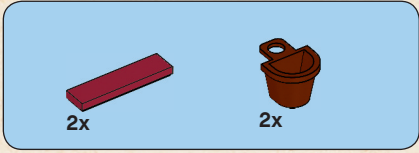

28

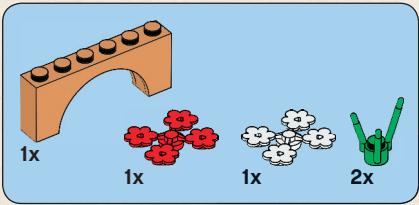
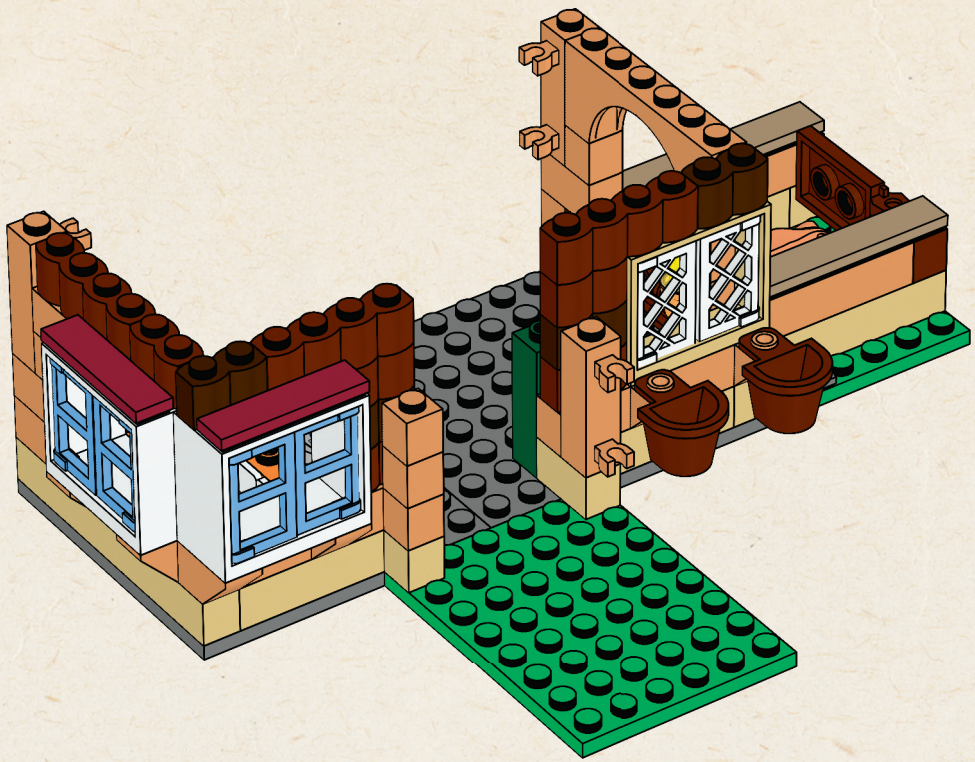

29

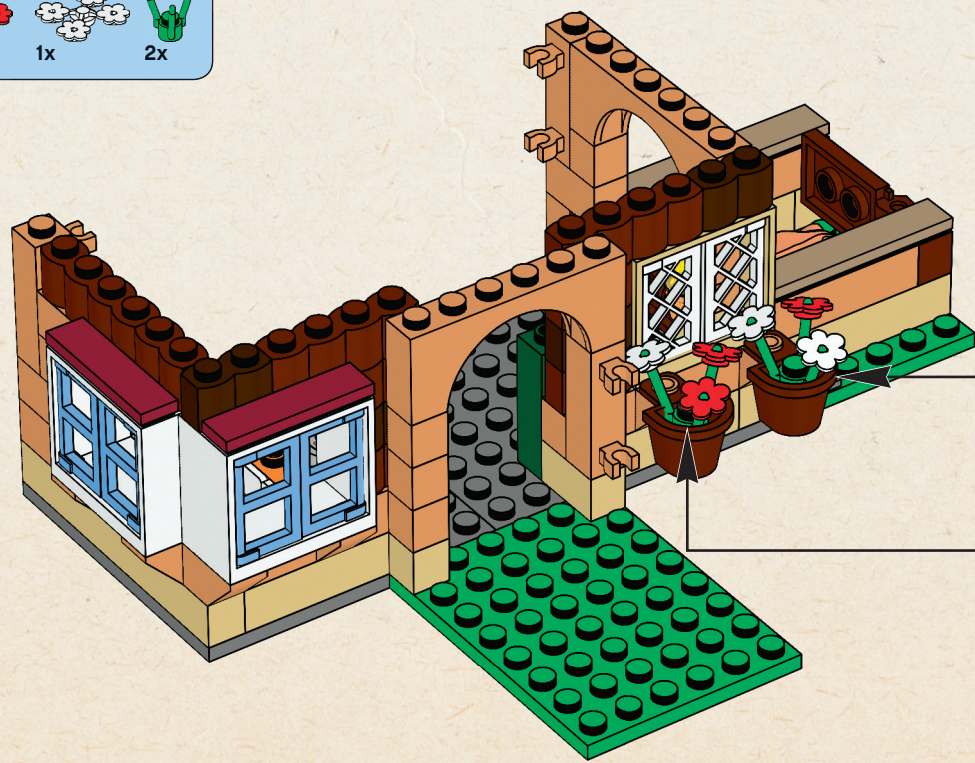

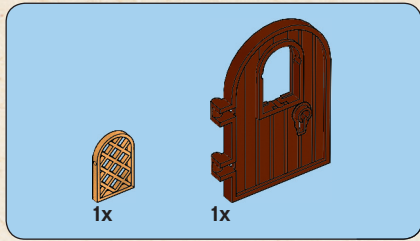

30

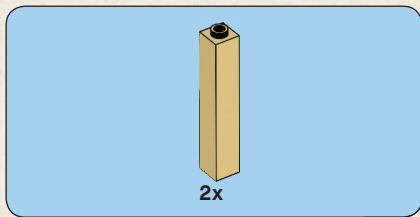
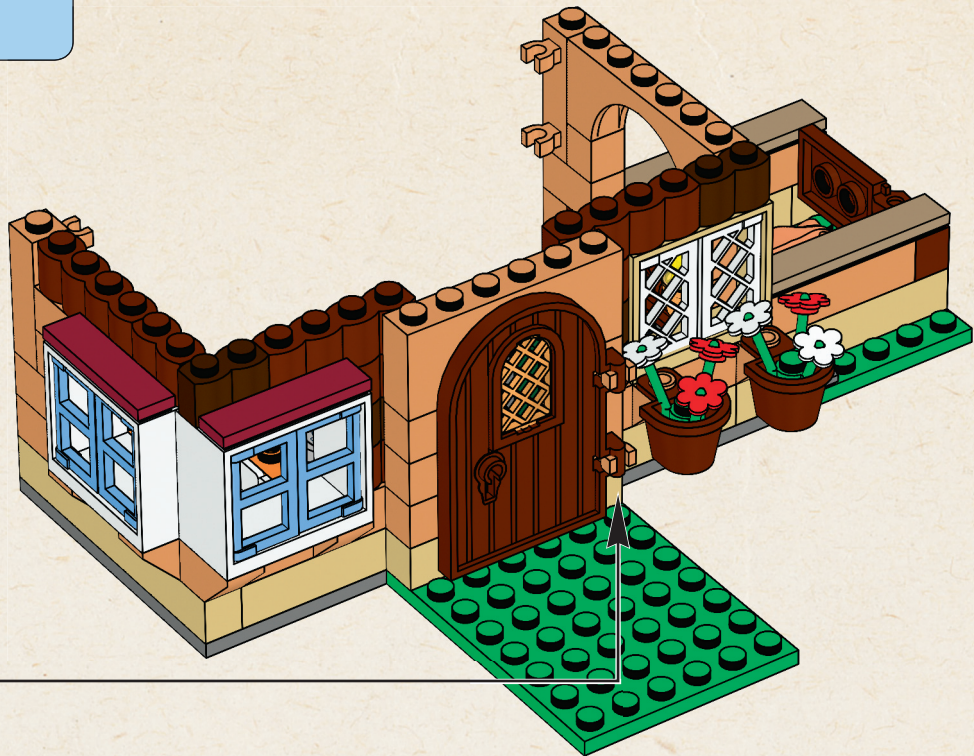
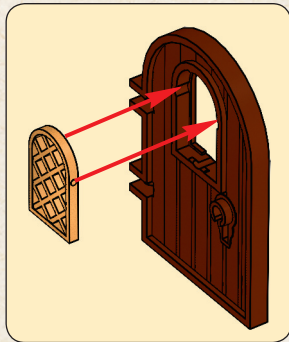

31

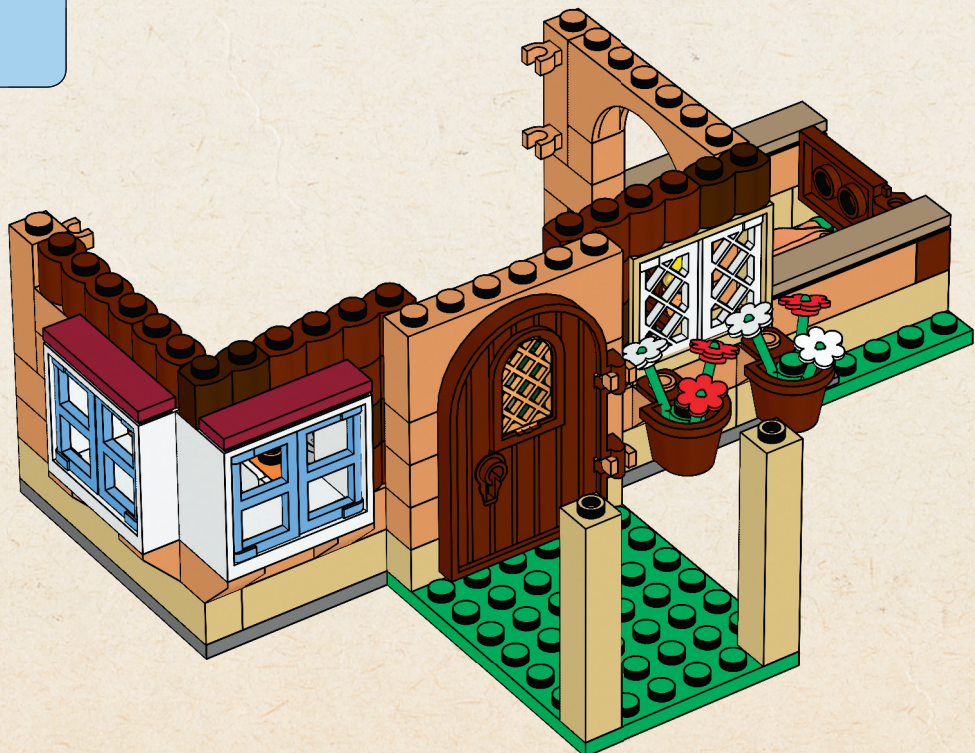

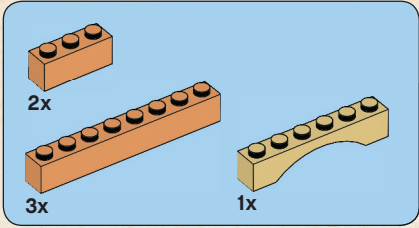

32

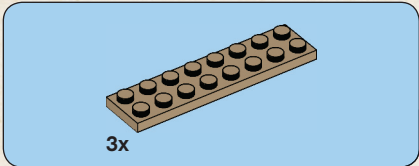
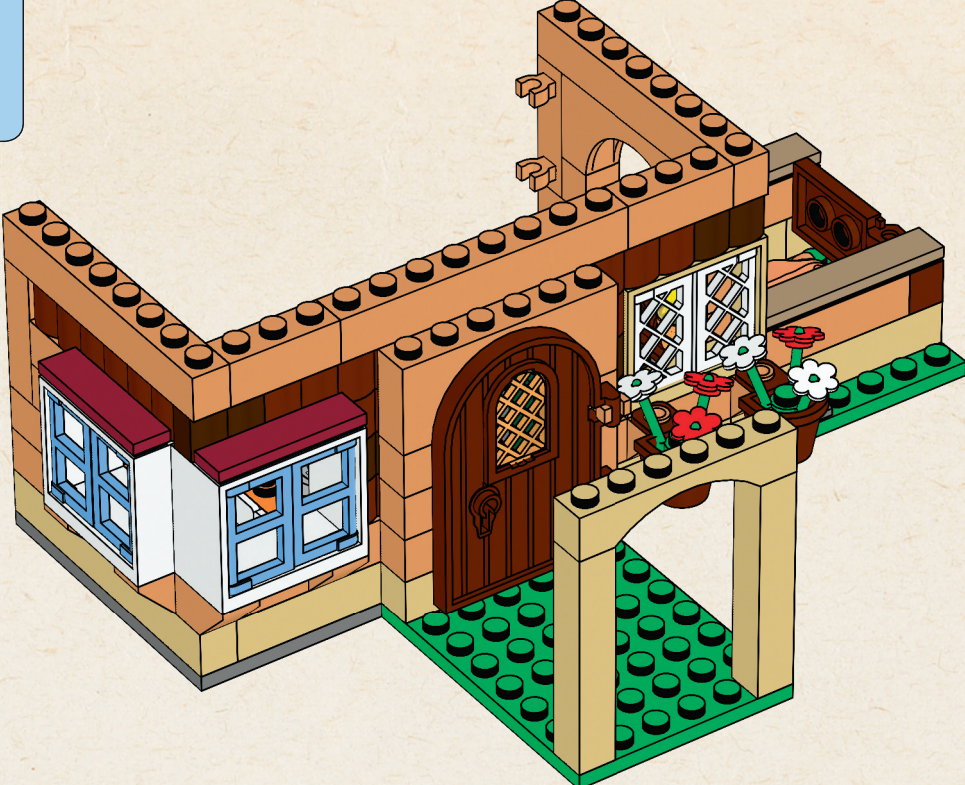

33

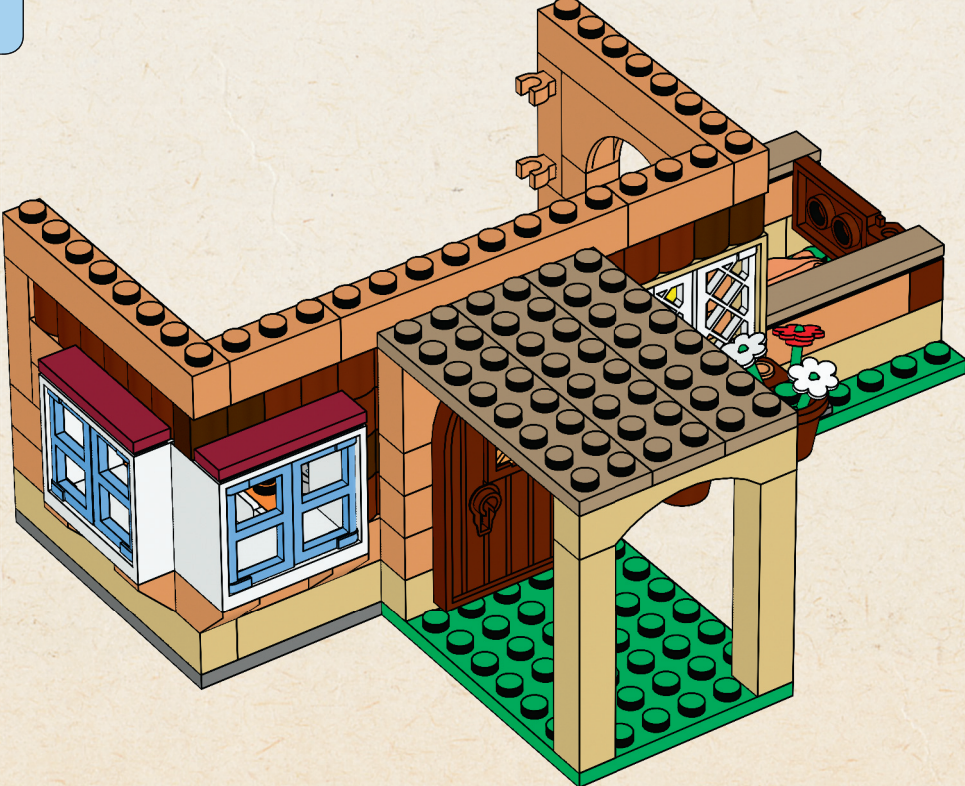

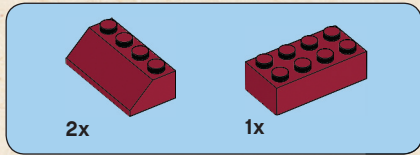

34

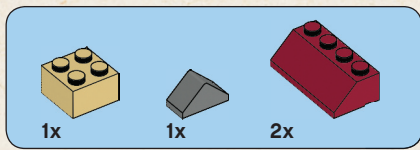
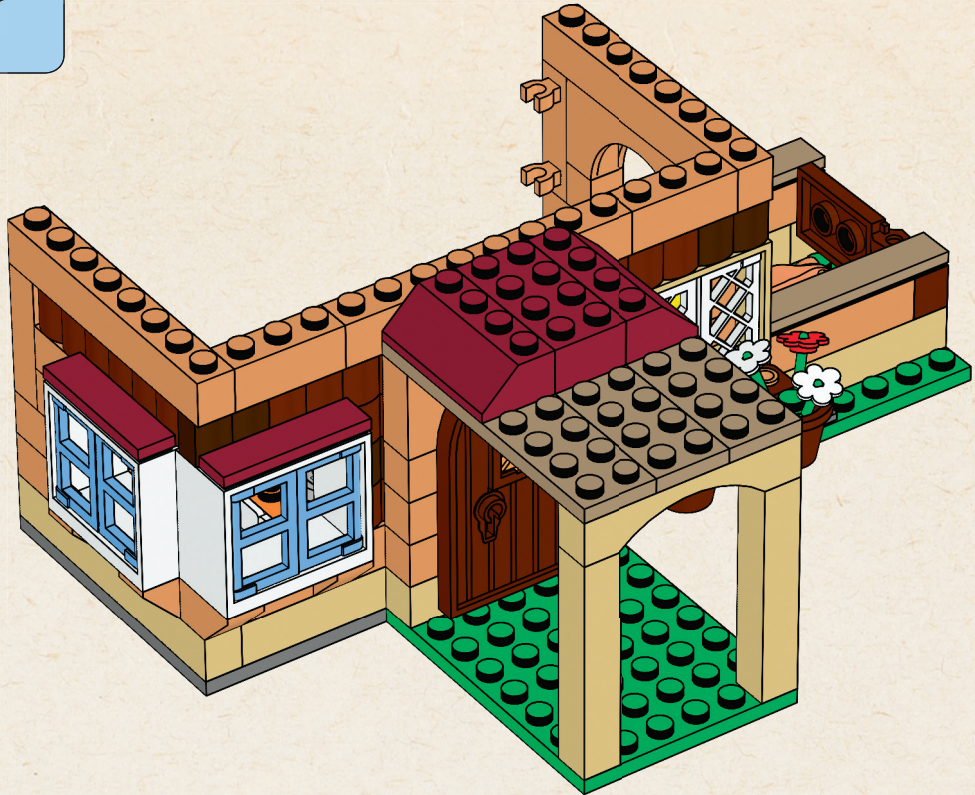

35

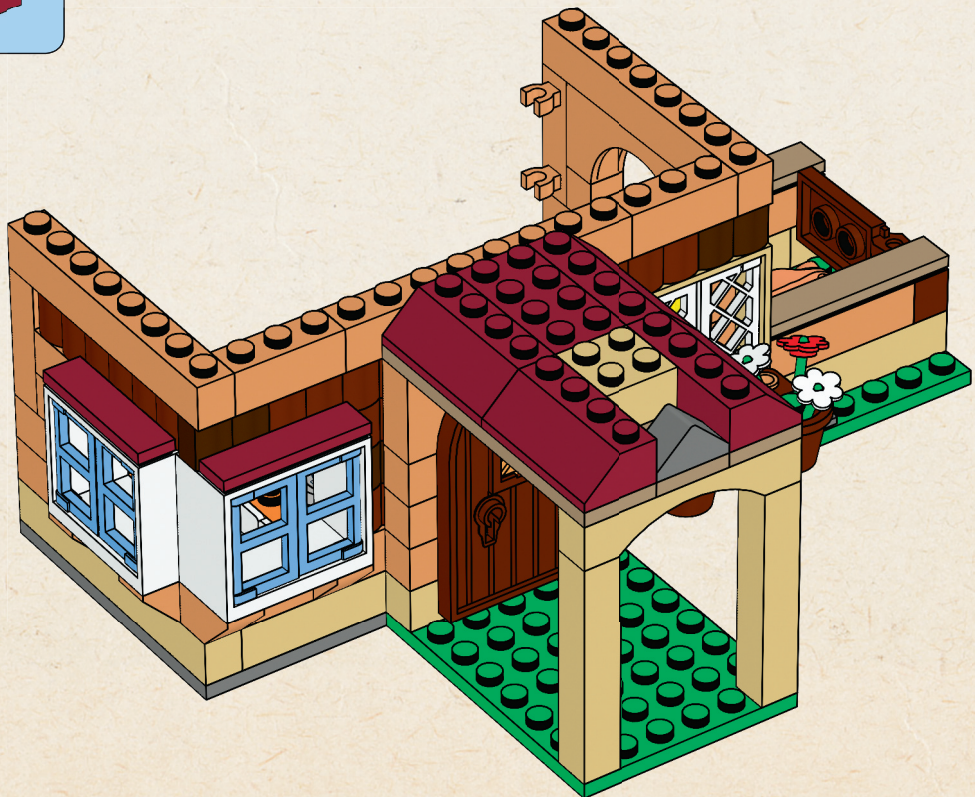

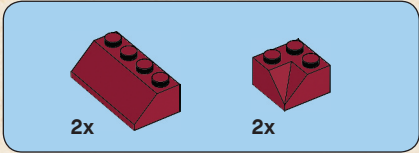

36

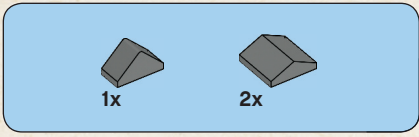
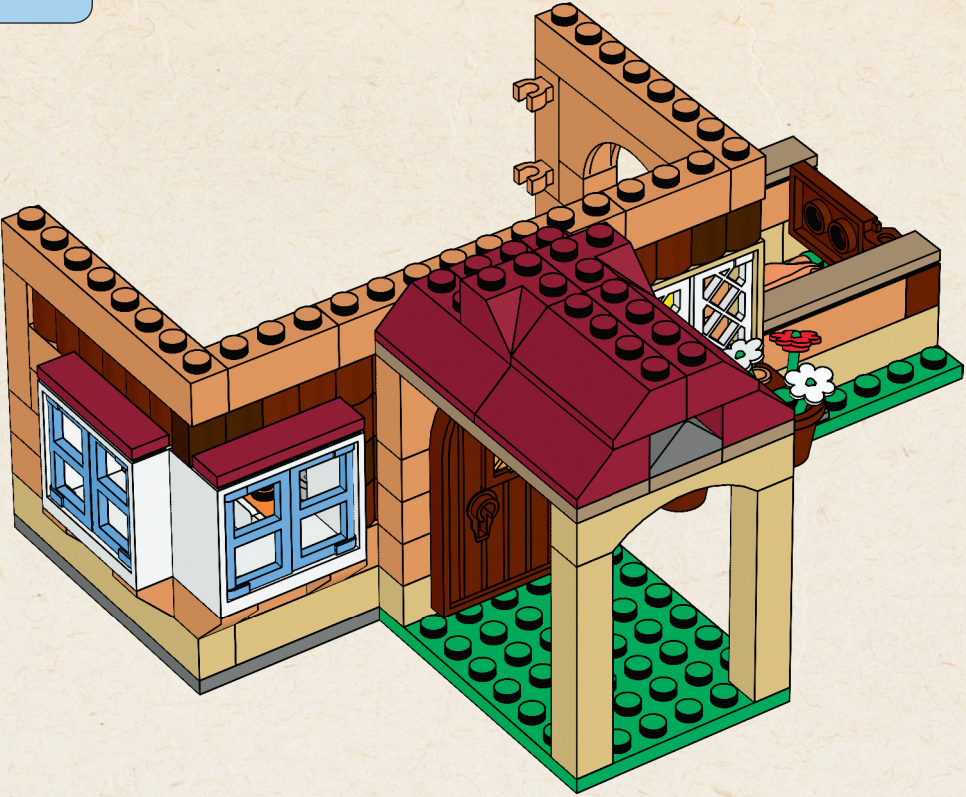

37

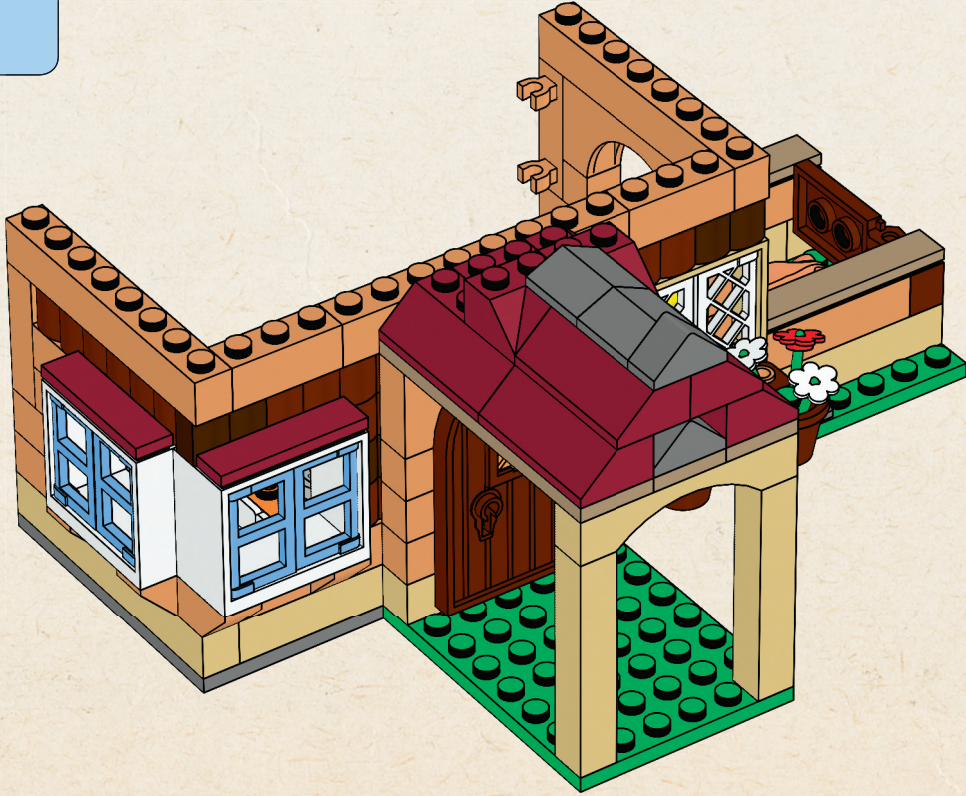

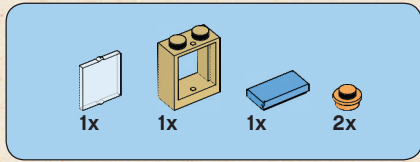

38

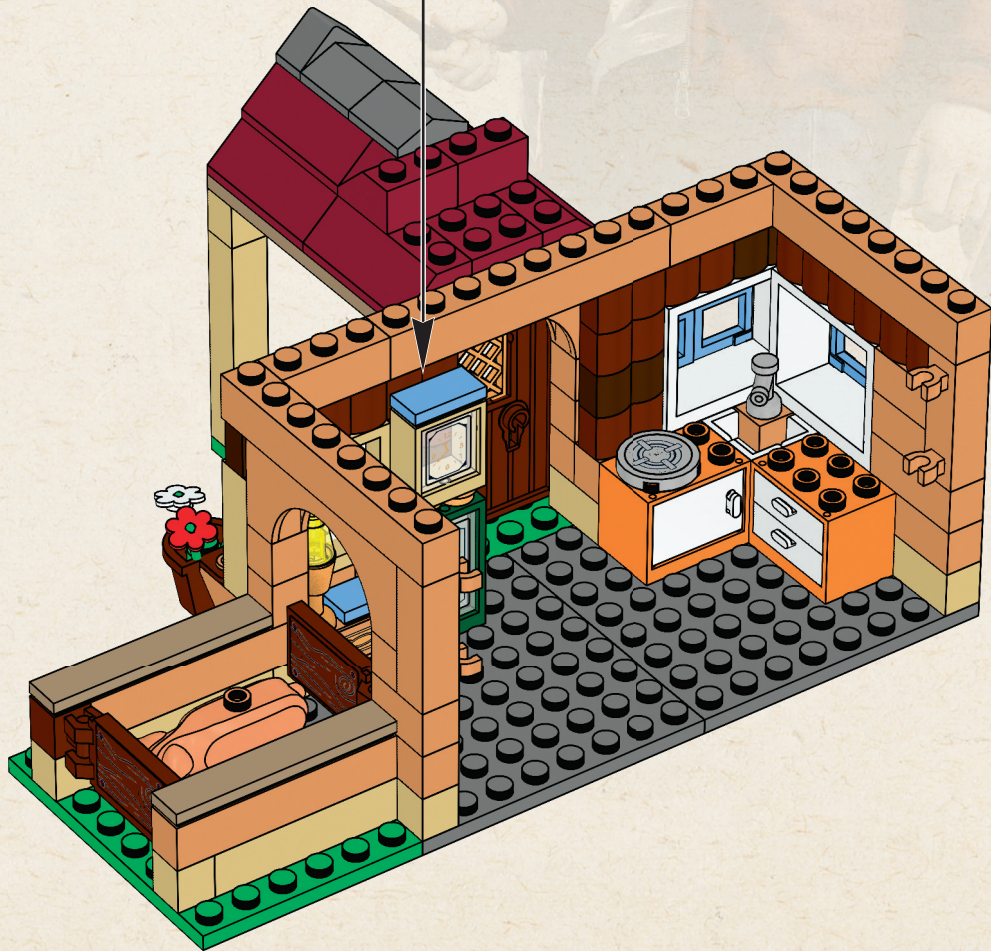
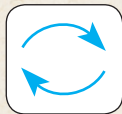
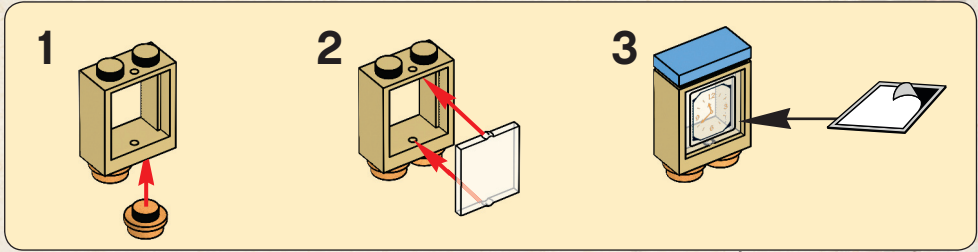

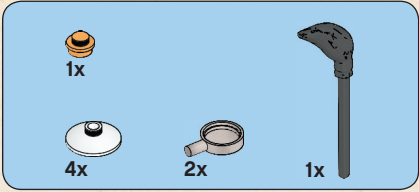

39

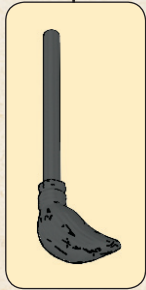
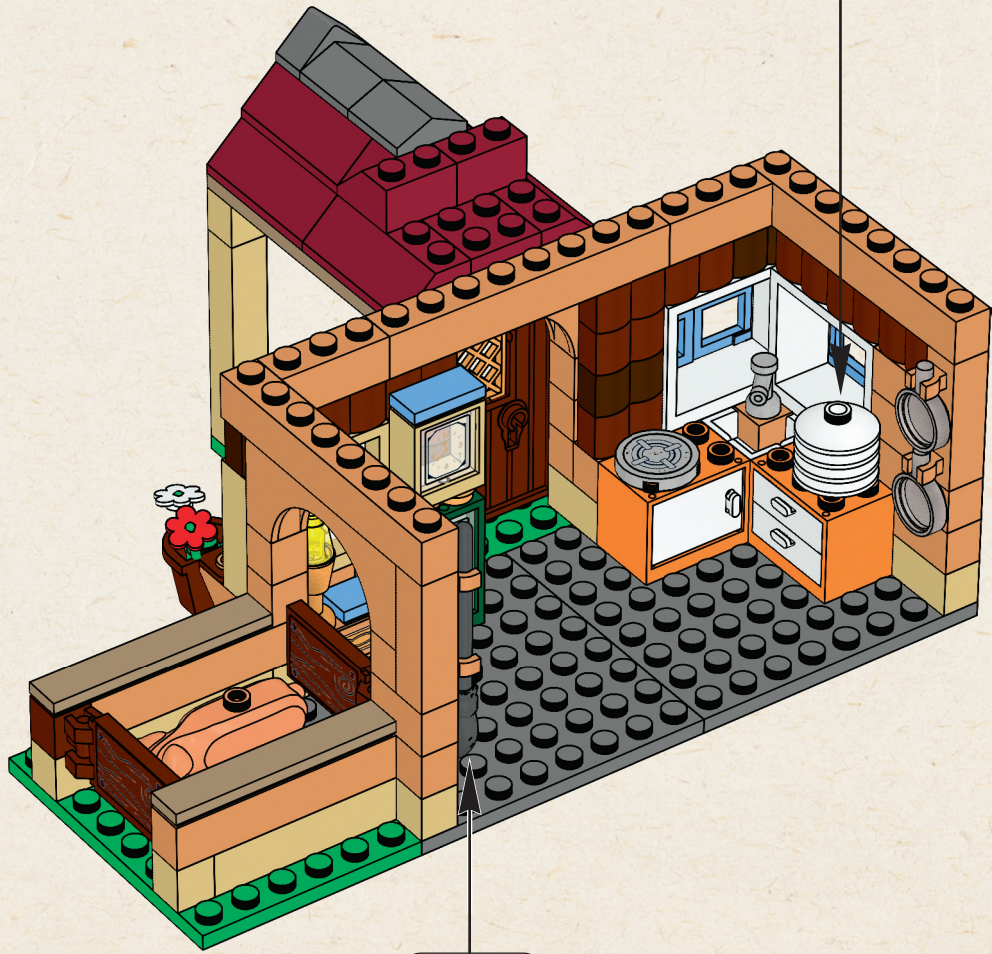
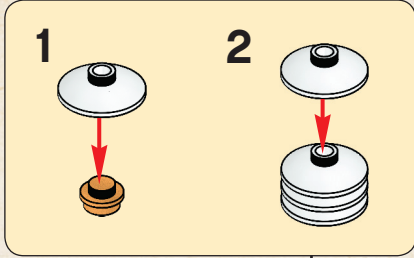

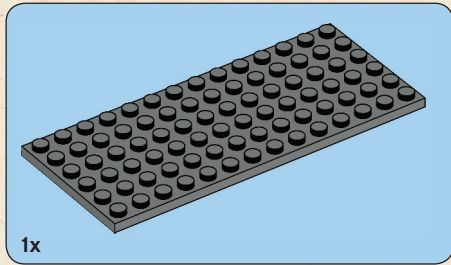

1x

40

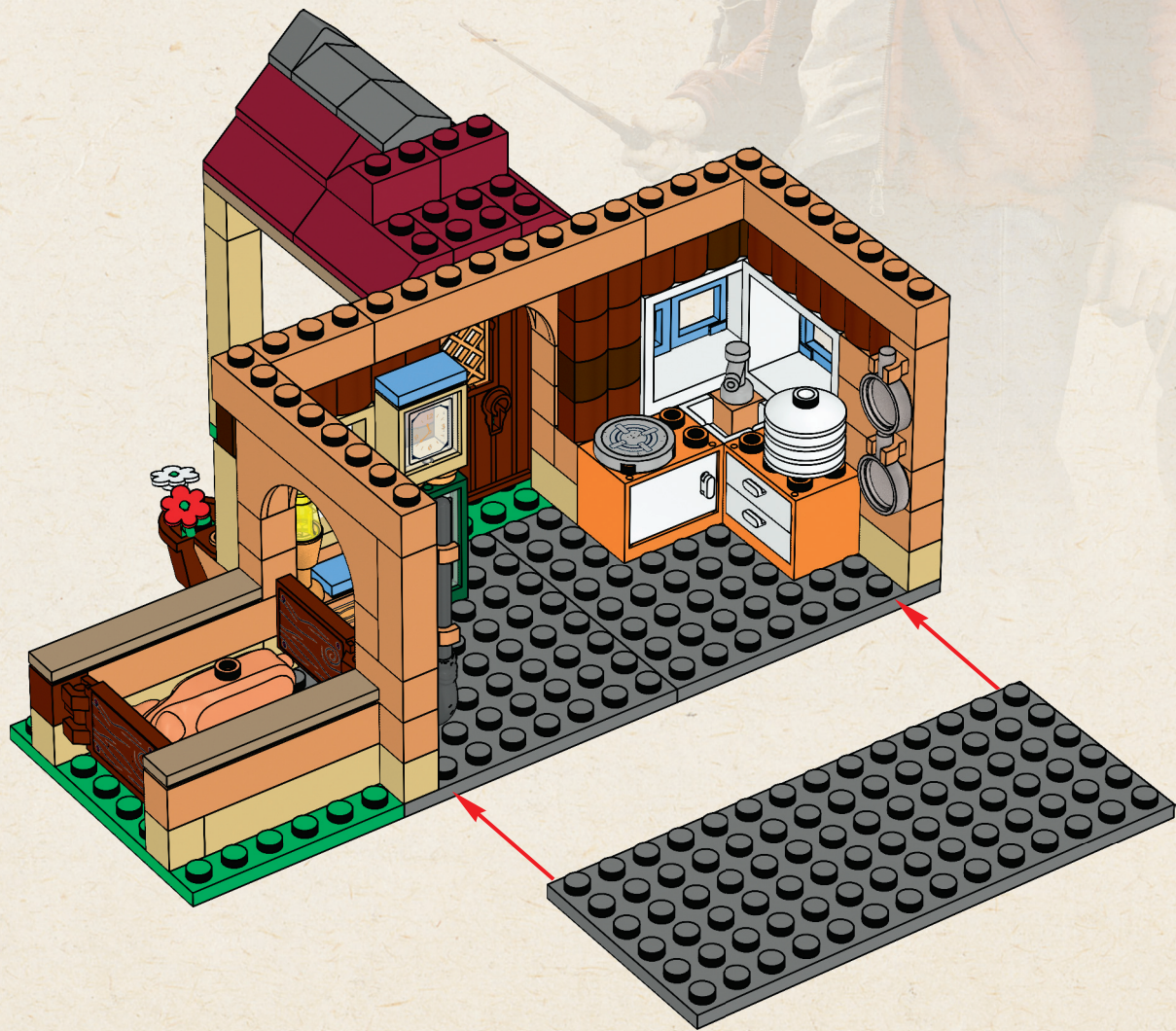

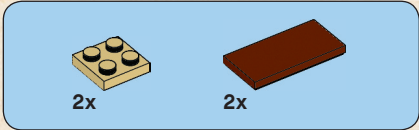

41

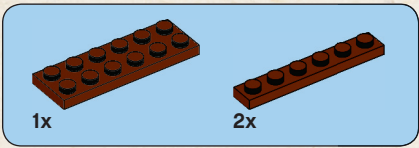
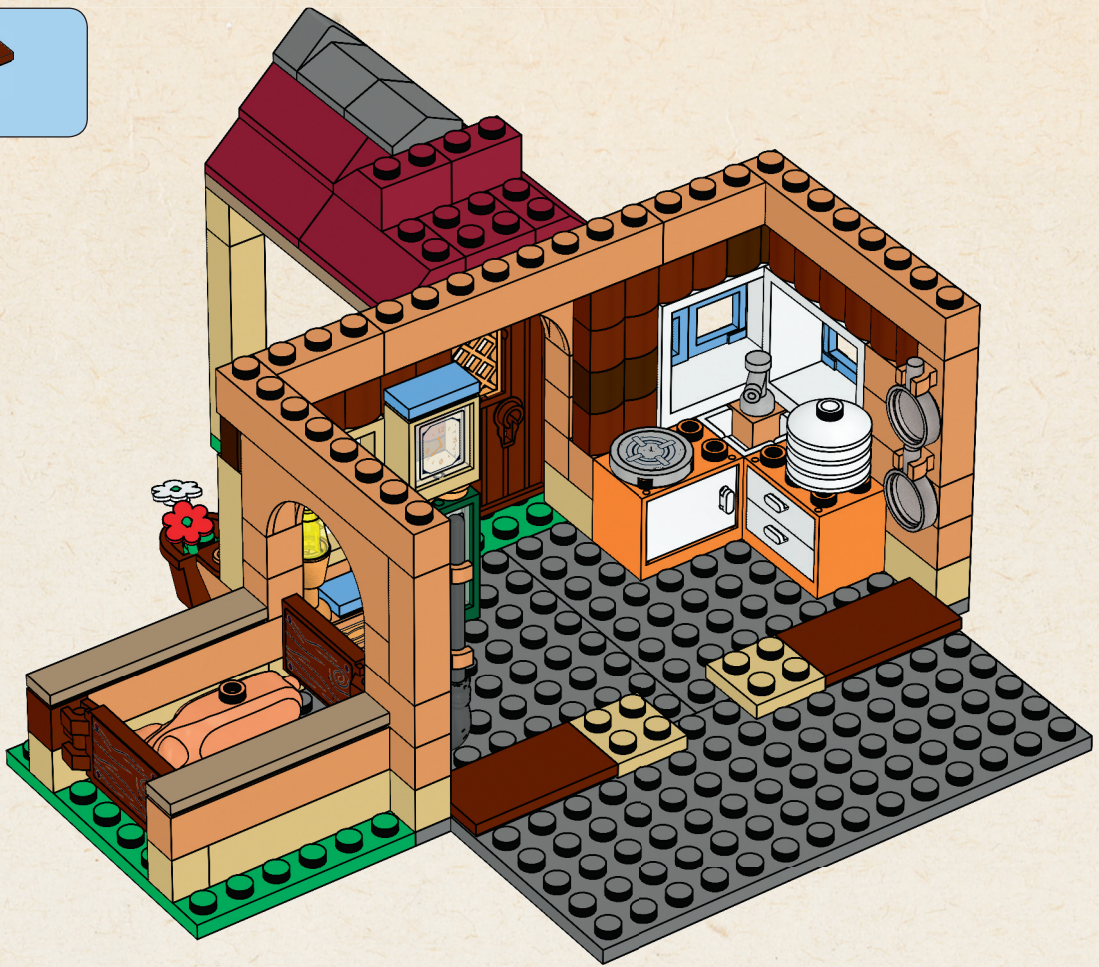

42





43

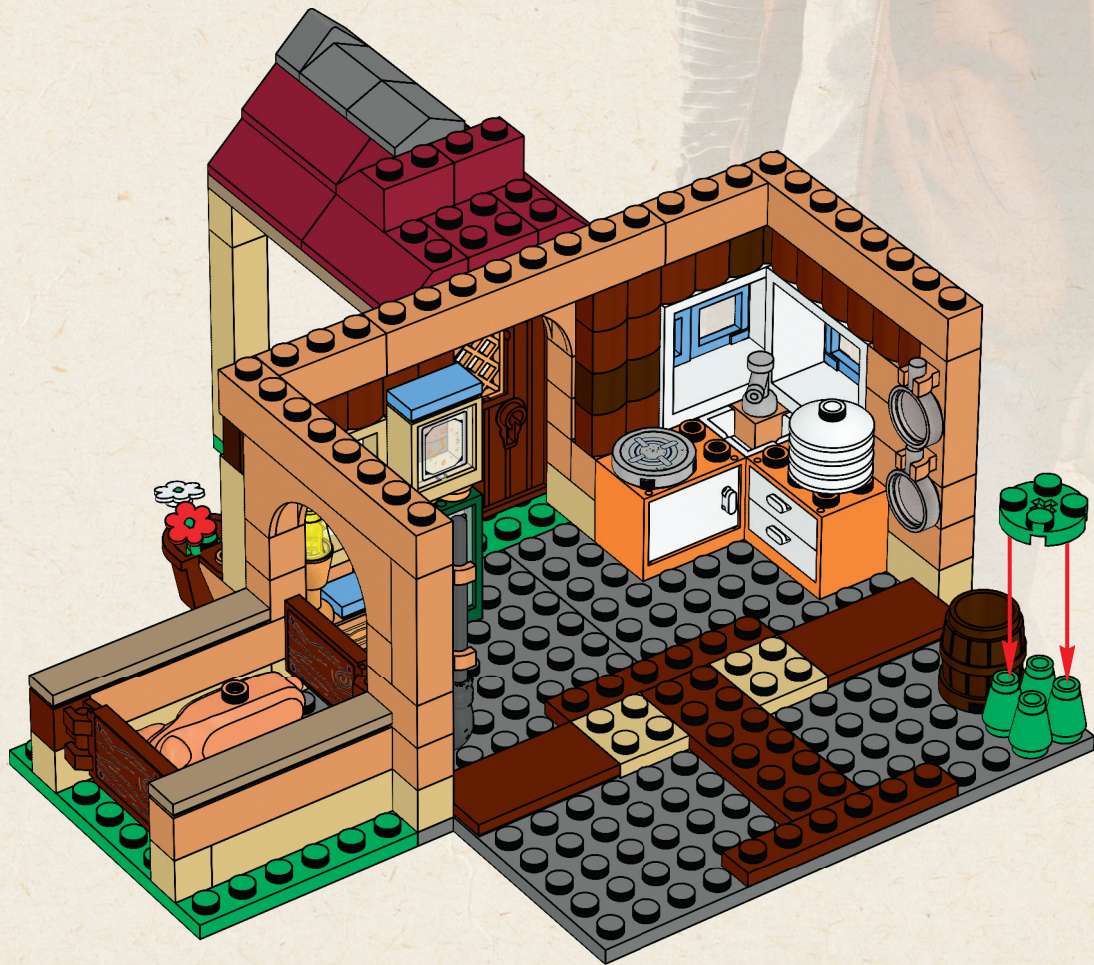

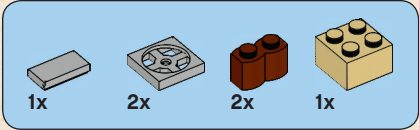

44



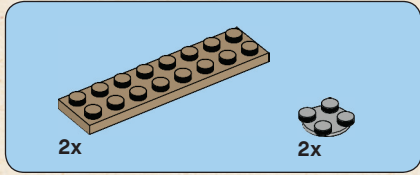

45

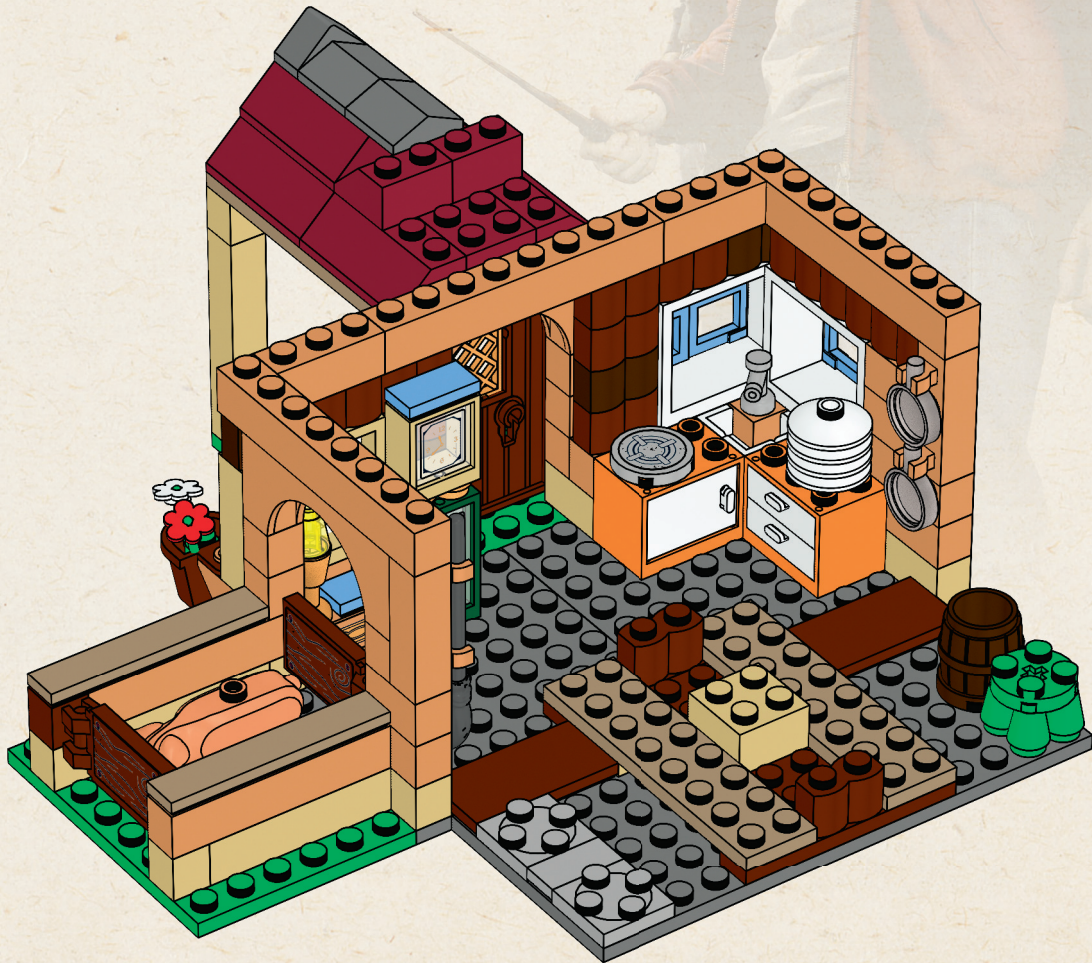

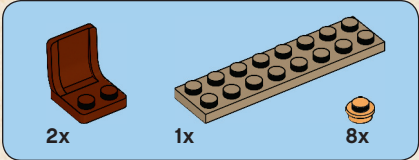

46

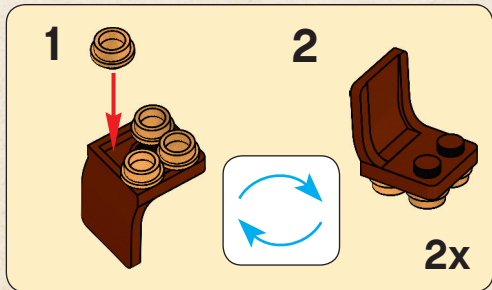

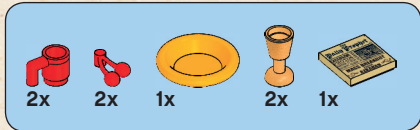

47

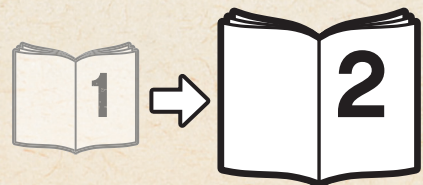



WOW!

Go to www.nielsen.com/LEGO to fill out a survey for a chance to win a cool LEGO® Product.

No purchase necessary.

Open to all residents where not prohibited.



www.LEGO.com



www.nielsen.com/LEGO

GEWINNE!

Nimm an der Umfrage auf www.nielsen.com/LEGO teil und hab die Chance ein cooles LEGO® Produkt zu gewinnen!

Die Teilnahme am Gewinnspiel führt zu keinerlei Kaufverpflichtungen. Teilnahme in allen nicht ausgeschlossenen Ländern möglich.

WIN!

Ga naar www.nielsen.com/LEGO, vul een enquêteformulier in en maak kans op een cool LEGO® product.

Geen aankoopverplichting. Iedereen mag deelnemen, uitgezonderd ingezetenden van landen waar een enquêteverbod geldt.

GAGNE!

Visite www.nielsen.com/LEGO pour répondre à un questionnaire et avoir une chance de gagner un produit LEGO® très cool!

Aucune obligation d'achat. Ouvert à tous les résidents des pays autorisés.

当てよう!

www.nielsen.com/LEGOにアクセスして、アンケートにご記入ください。当選者にはレゴ製品を差し上げます。

お買い上げの必要はありません。禁止されていない限り、すべての管轄にご利用いただけます。

LEGO and the LEGO logo are trademarks of the LEGO Group. ©2010 The LEGO Group. © 2010 Lucasfilm Ltd. & TM. All rights reserved. Used under authorization. HARRY POTTER, characters, names and related indicia are trademarks of and © Warner Bros. Entertainment Inc. Harry Potter Publishing Rights © JKR. TM & © Warner Bros. Entertainment Inc. (s10)