

The LEGO logo is displayed in its classic white font with a black outline, set against a red square background.

THE LEGO MOVIE



70821



WARNING: CHOKING HAZARD.
Toy contains small parts and a small ball.
Not for children under 3 years.





1



2

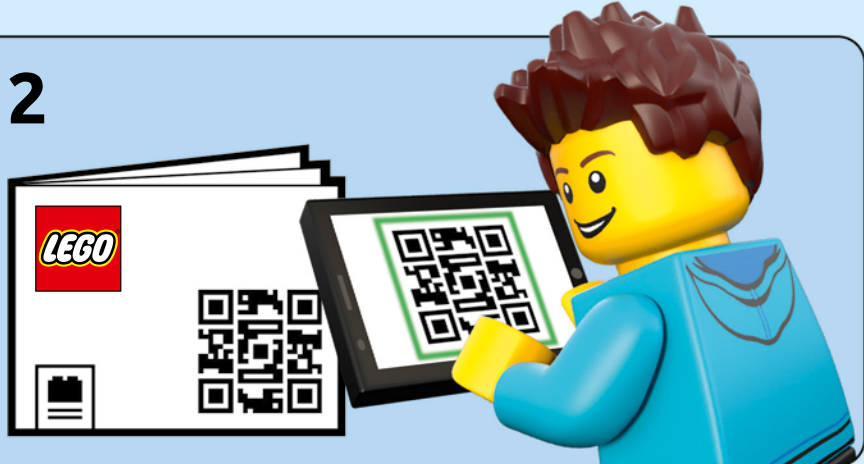

3

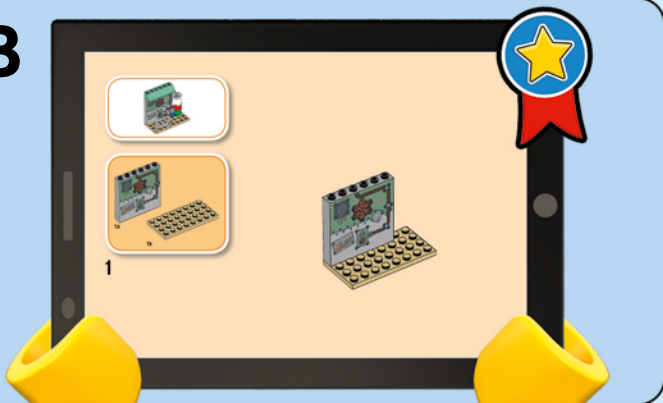

LEGO.com/apps

Check for compatibility
Vérifier la compatibilité
Comprueba tu compatibilidad



AVERTISSEMENT : RISQUE D'ÉTOUFFEMENT.
Le jouet contient des petites pièces ainsi qu'une petite boule.
Il ne convient pas aux enfants de moins de 3 ans.



ADVERTENCIA: PELIGRO DE ASFIXIA.
Juguete que contiene partes pequeñas y una pelota pequeña.
No recomendado para niños menores de 3 años.

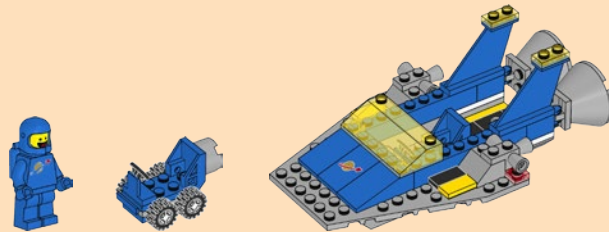
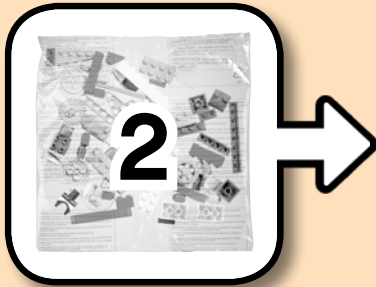
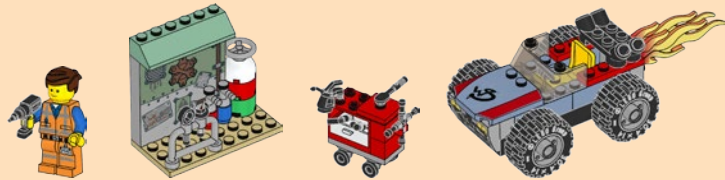
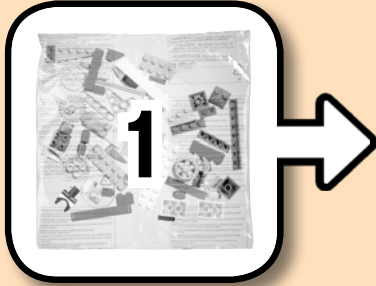

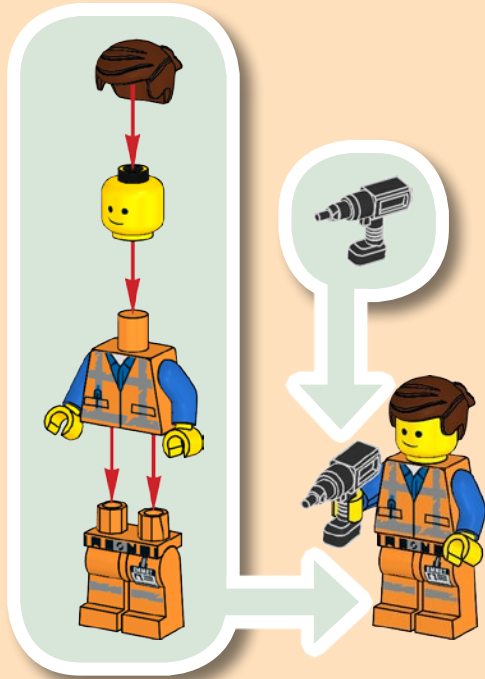
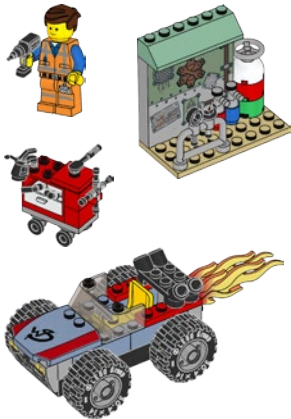

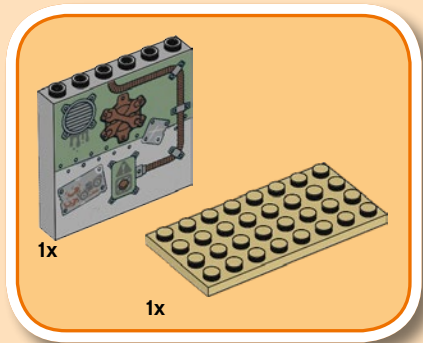
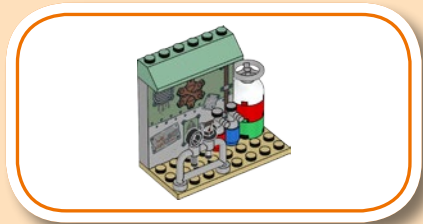

1

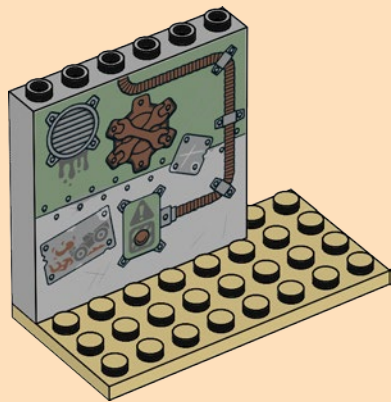

6



2

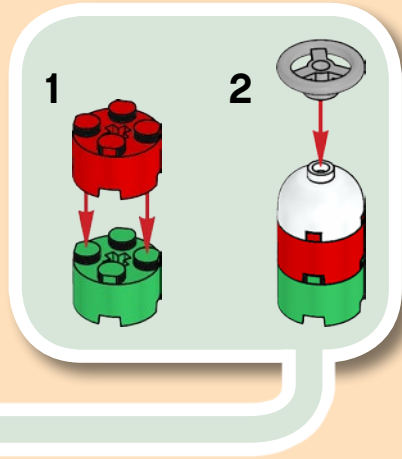
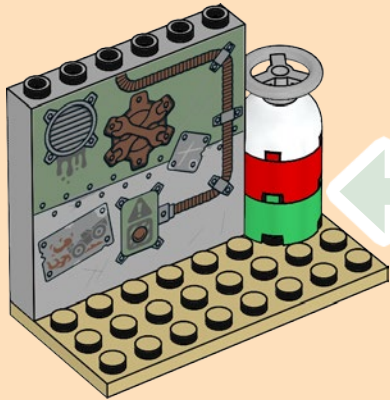

1x 1x 2x

3

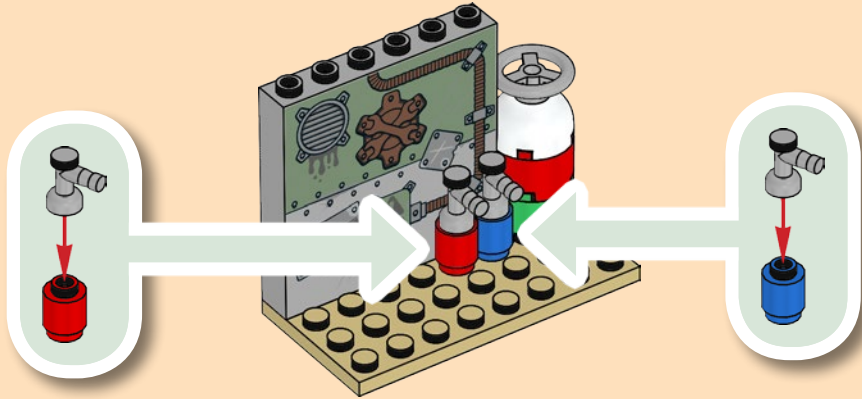

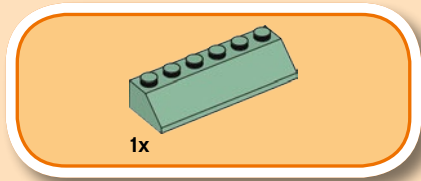

4



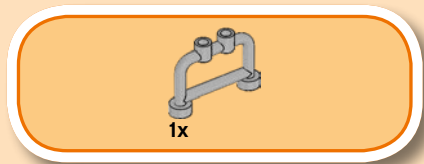

5

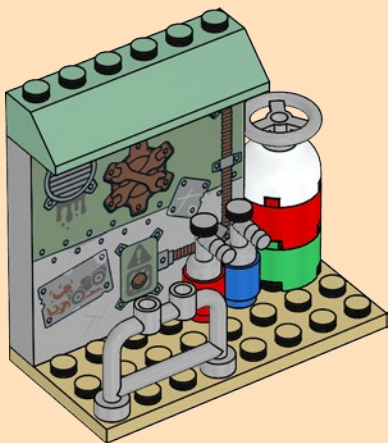

6

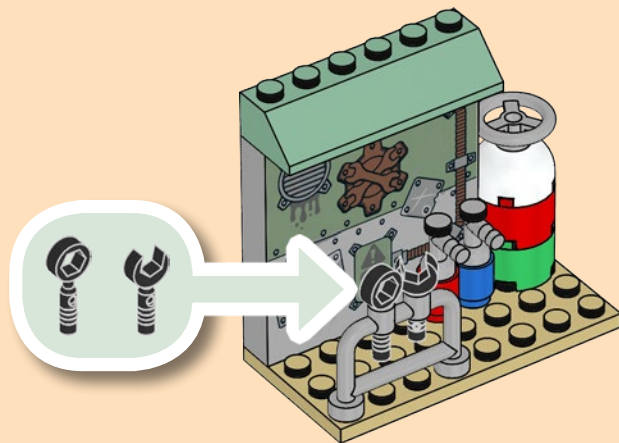



1x



1x

1

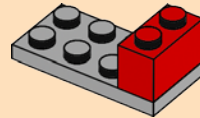

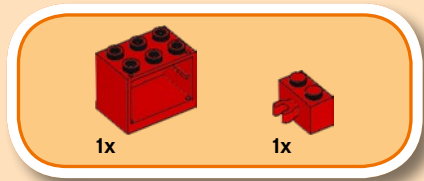

2

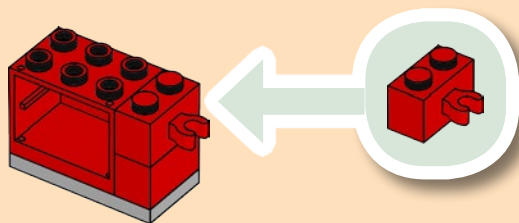

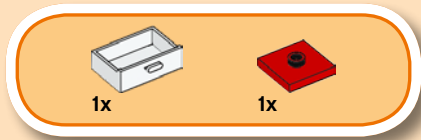

3

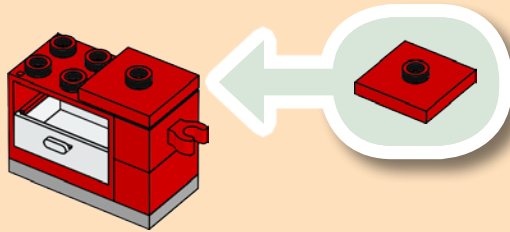

4

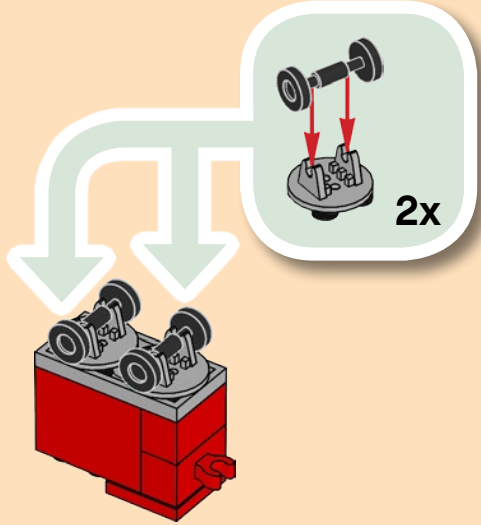
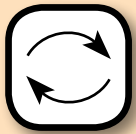

5

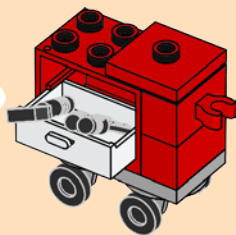

6

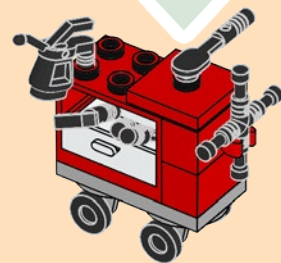

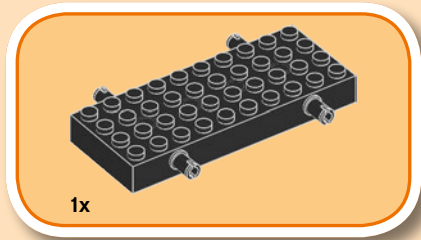
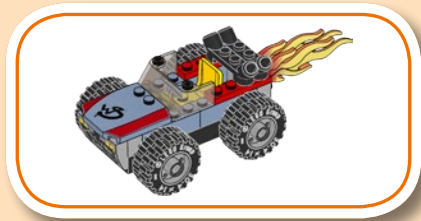

1

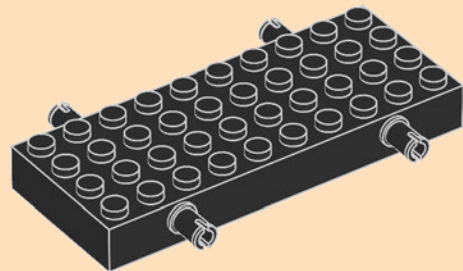



4x

2

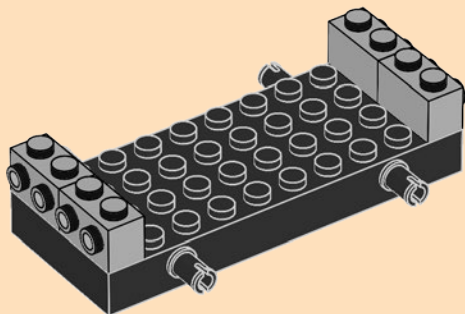

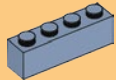

4x

3

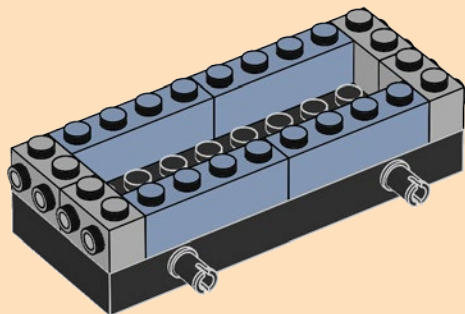



4

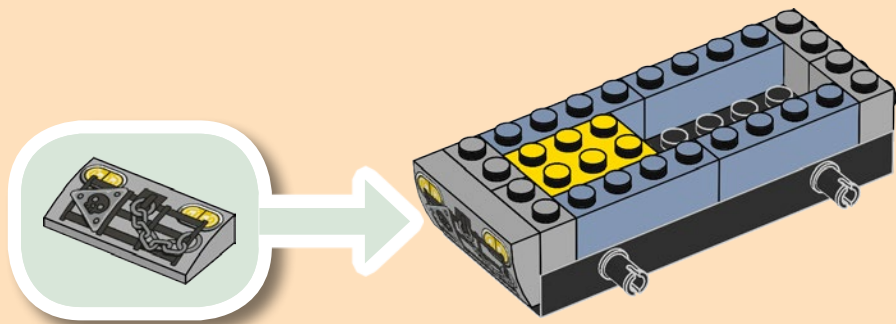



5

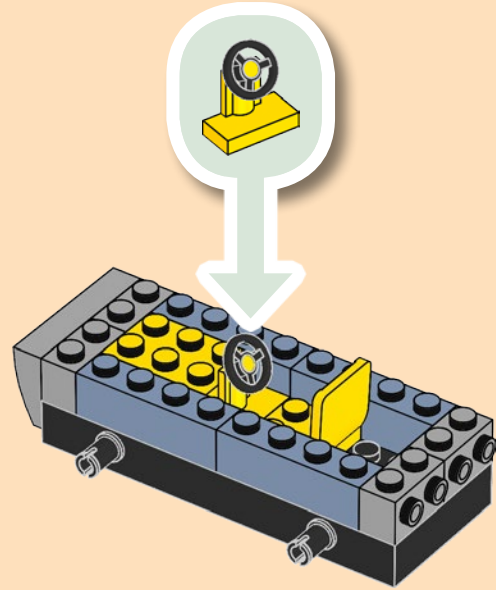

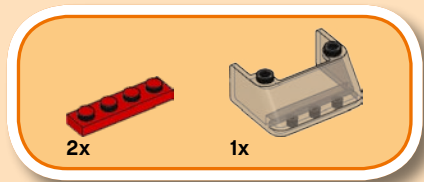

6

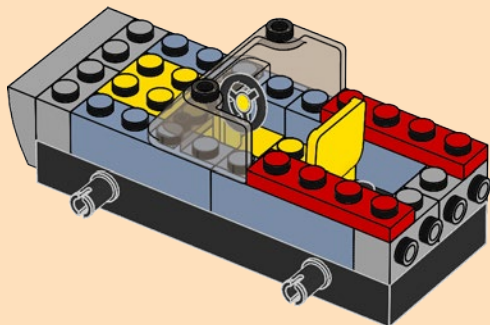



1x

7

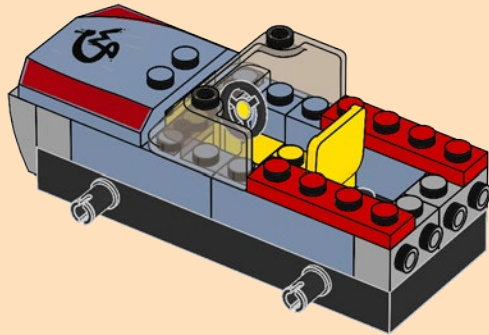



2x

8

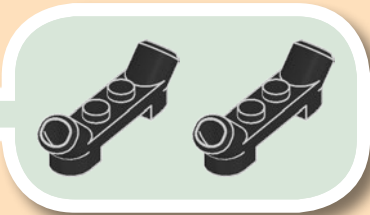
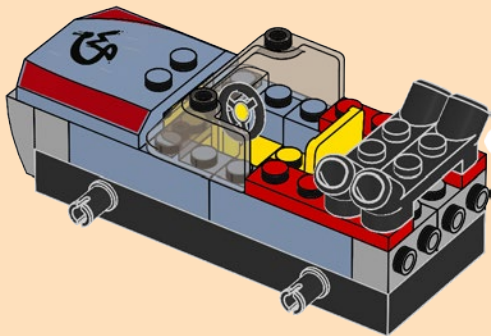



9

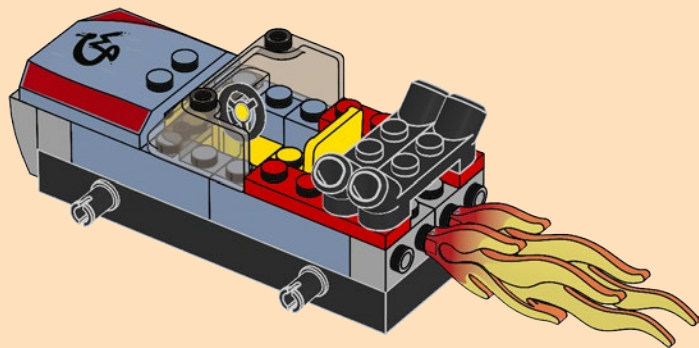

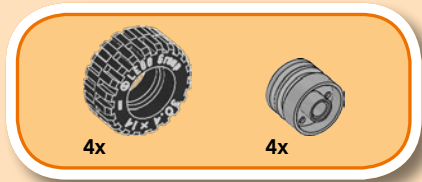

10

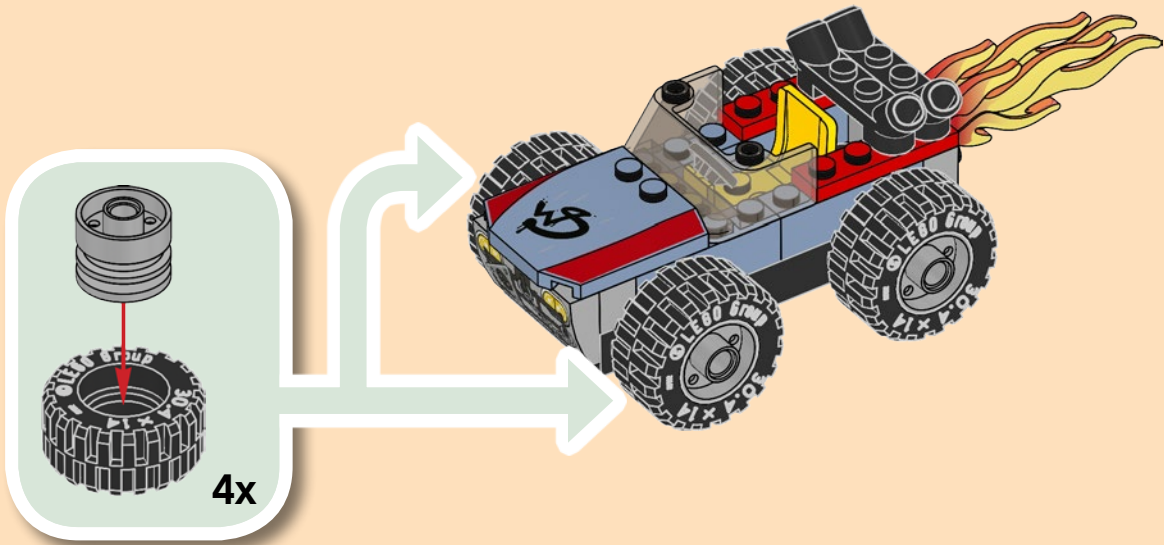

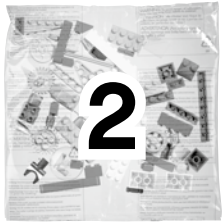
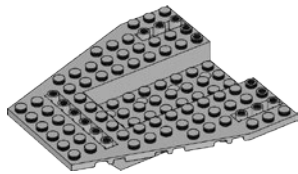

1x



1x



1x



1x



1x

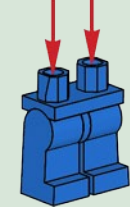
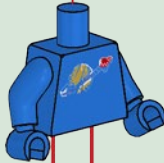
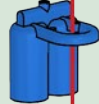



1x

1

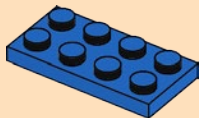

2x

2

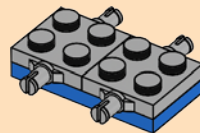



1x

3

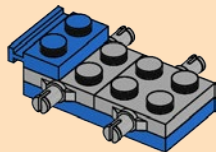

1x

4

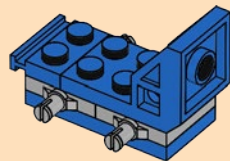

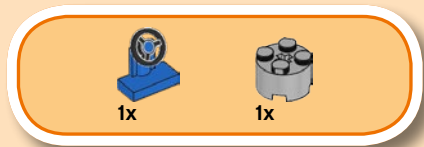

5

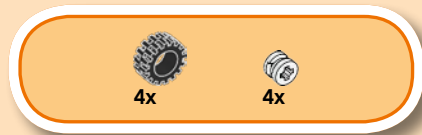
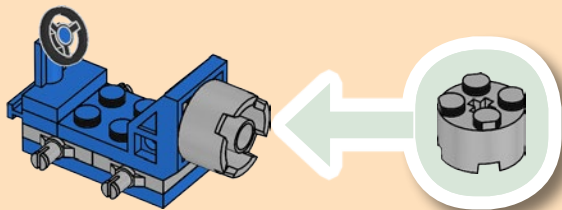

6

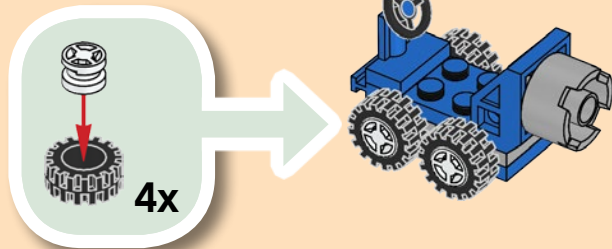

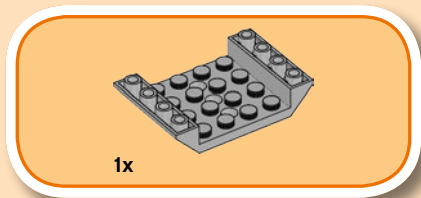
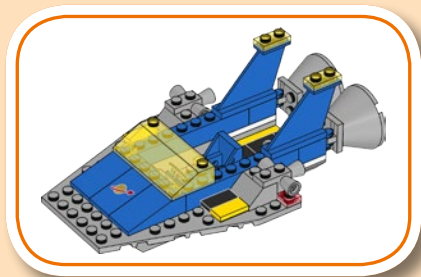

1

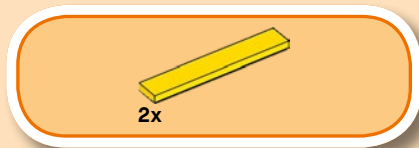
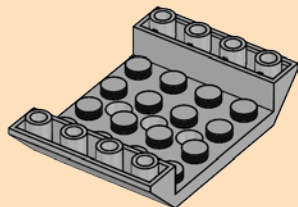

2

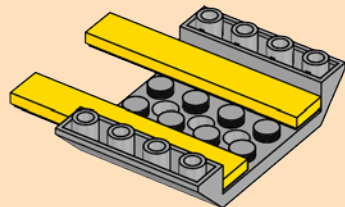

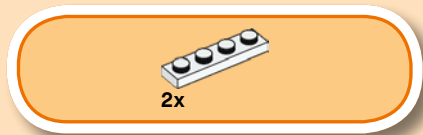

3

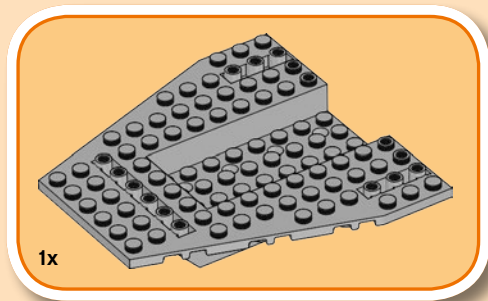
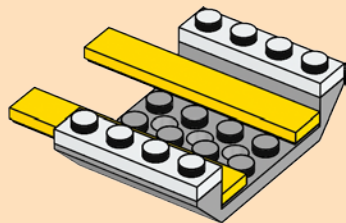

4

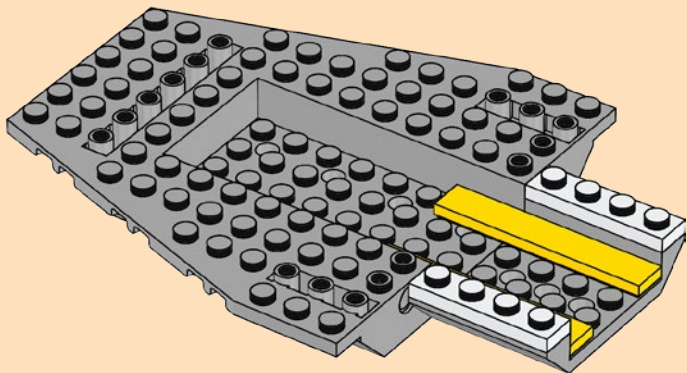



1x



1x

5

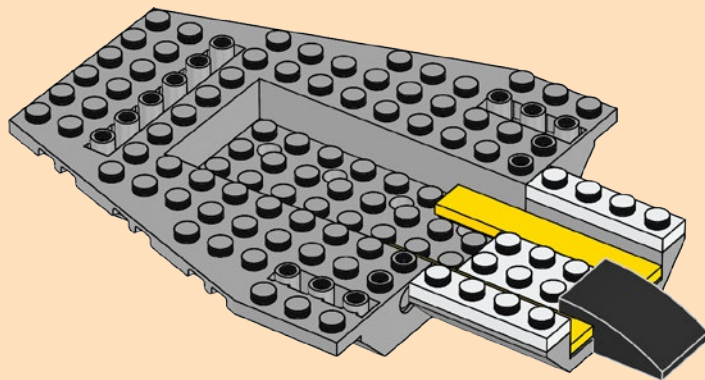



6

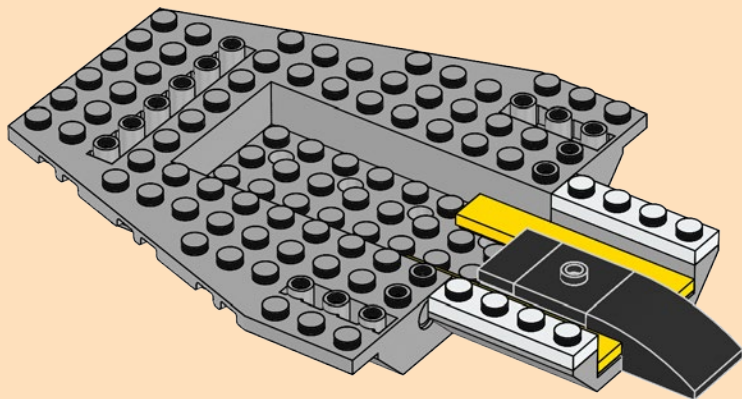



2x

7

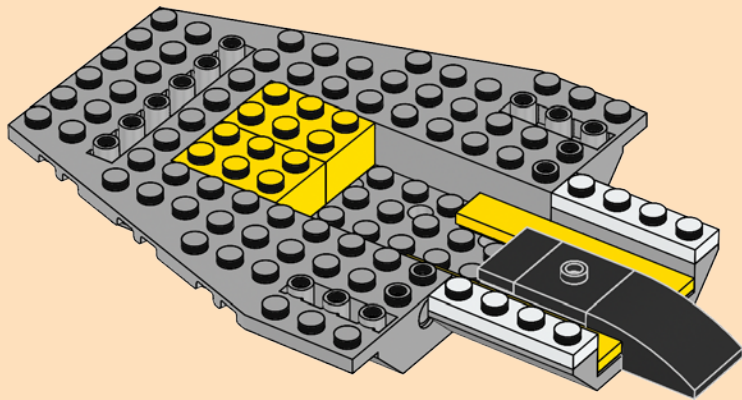

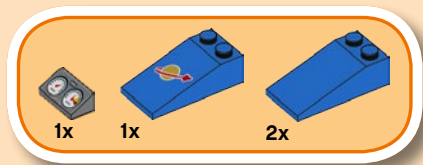

8

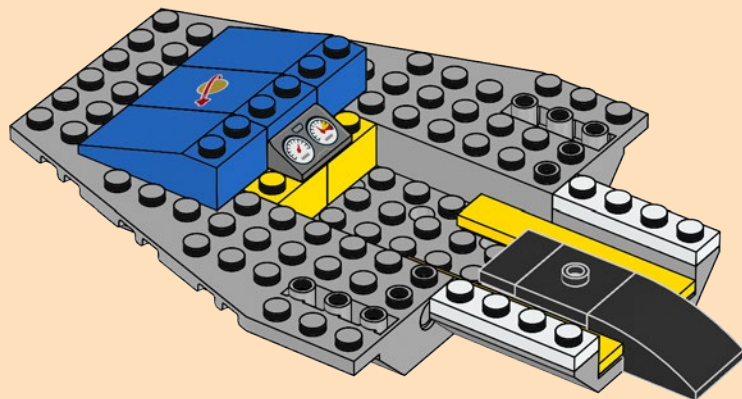

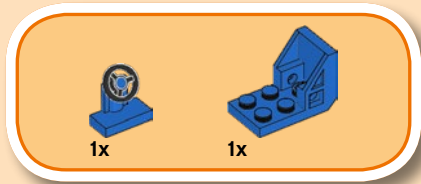

9

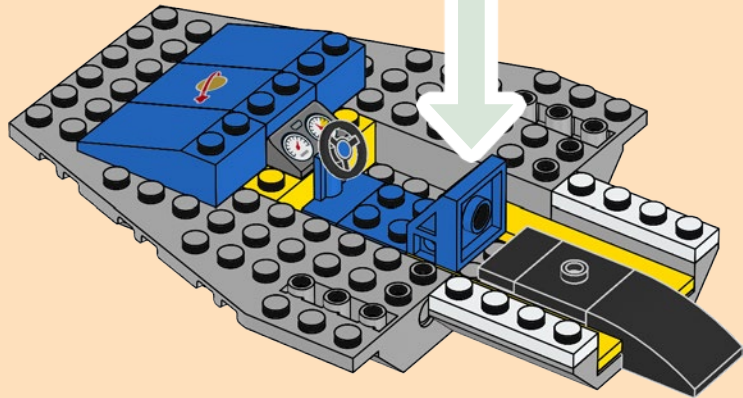
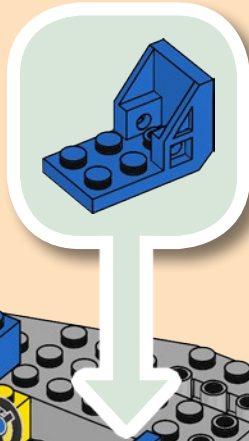

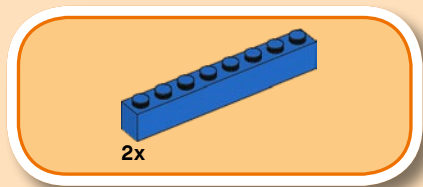

10

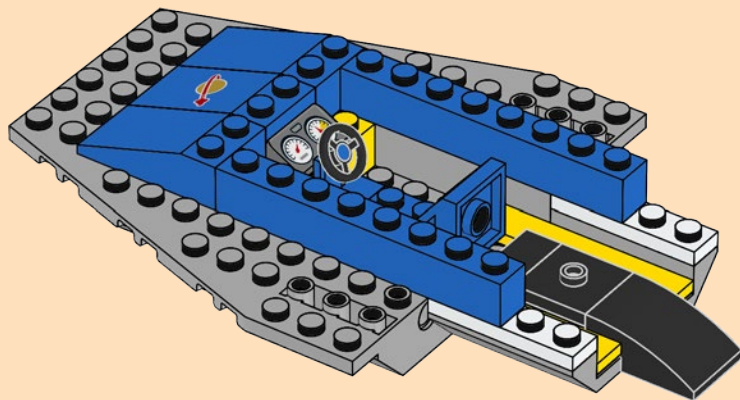



2x

11

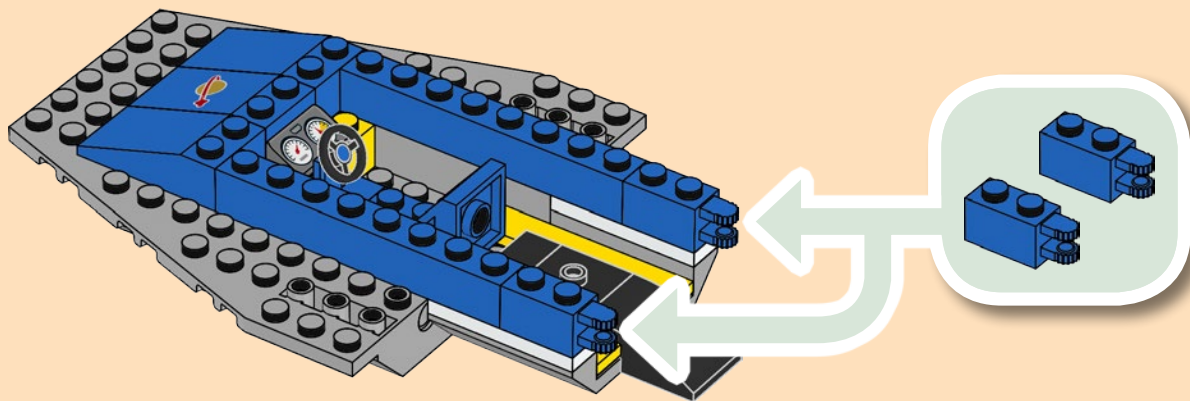

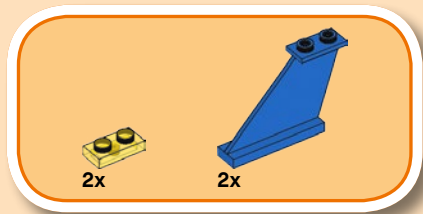

12

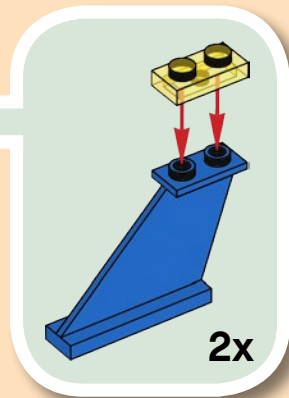
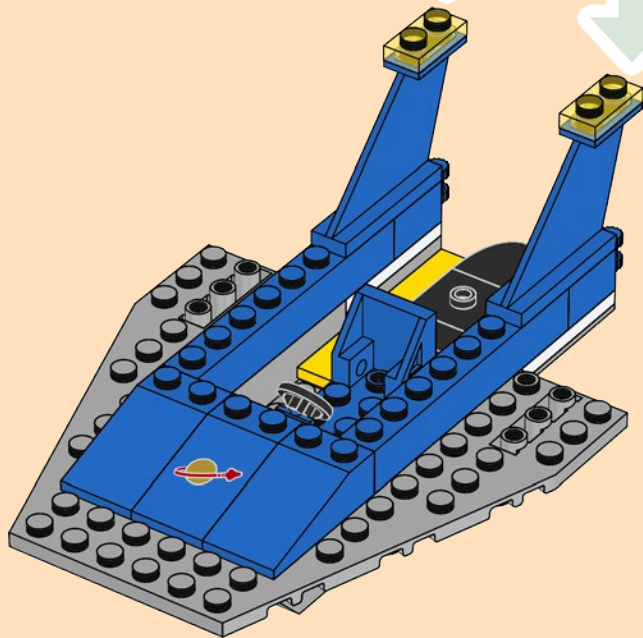

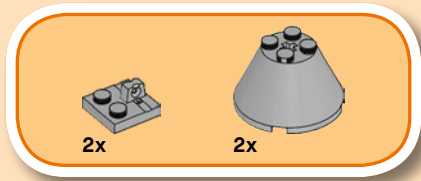

13

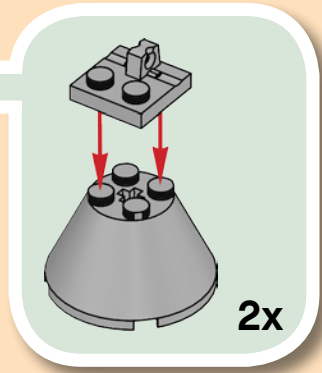
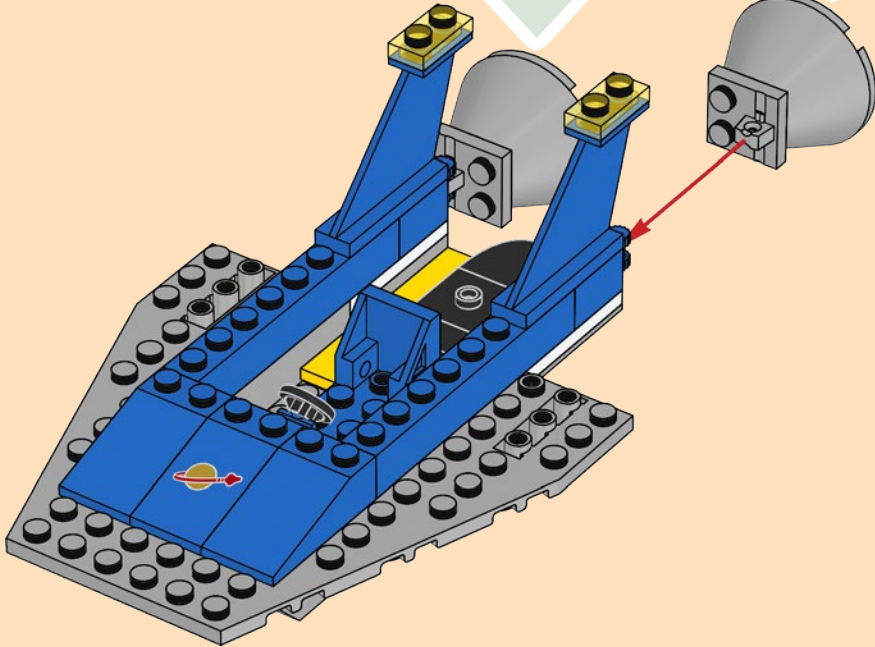



2x

14

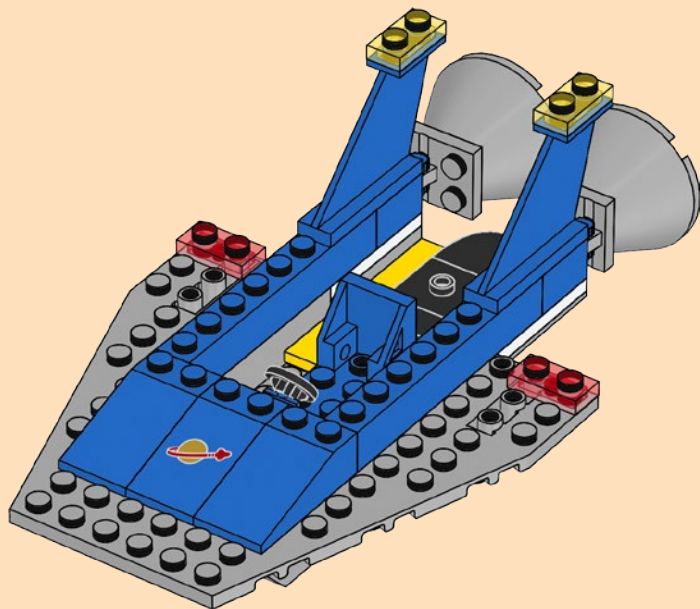



15

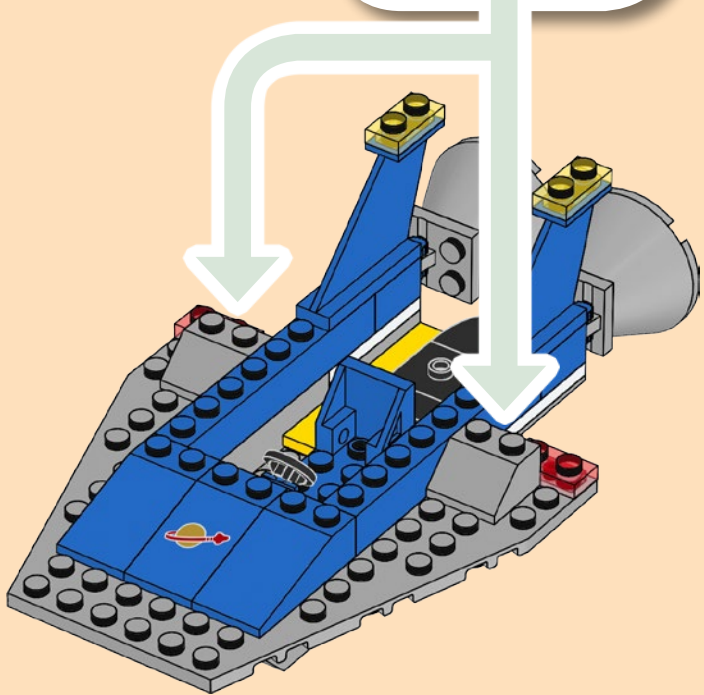
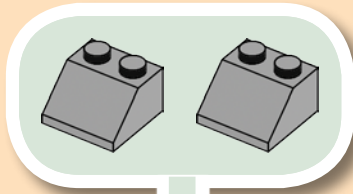



2x



2x

16

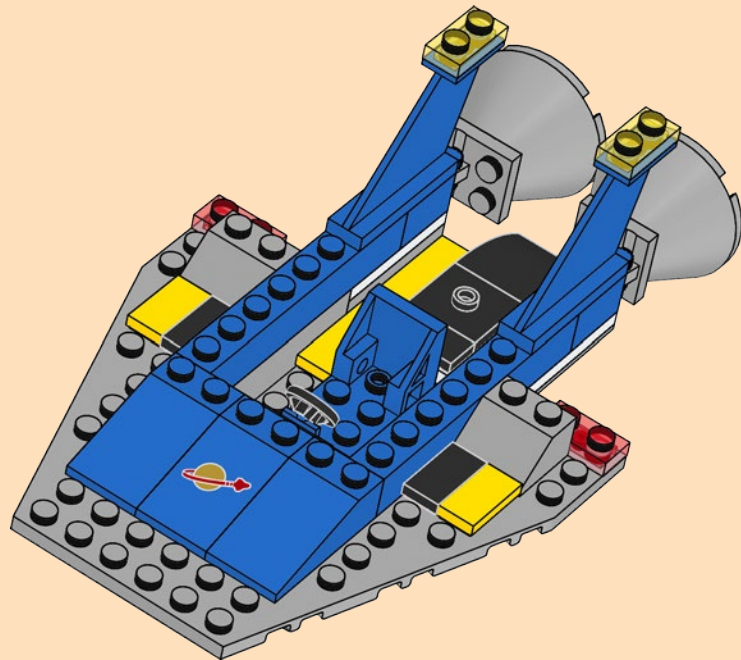

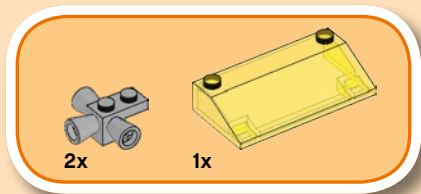

17

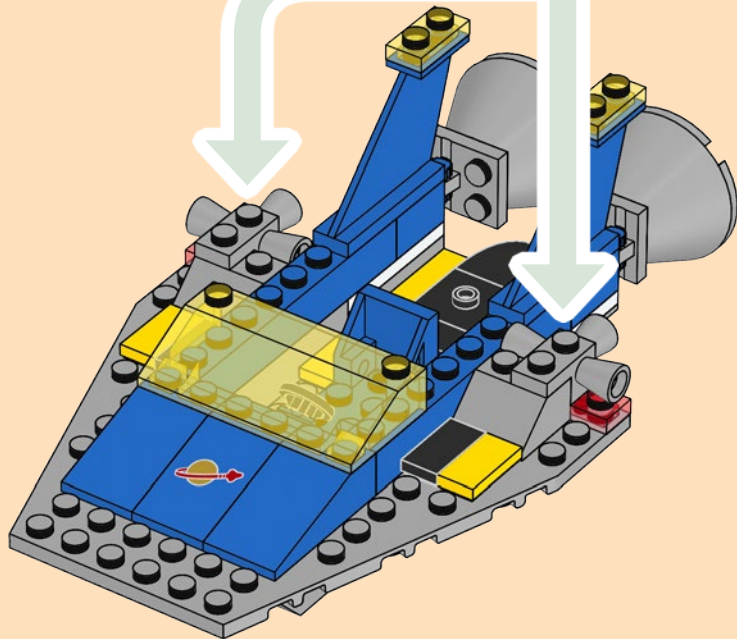
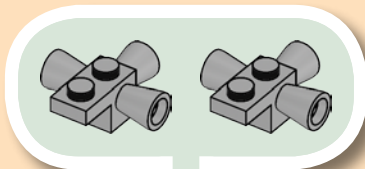

1

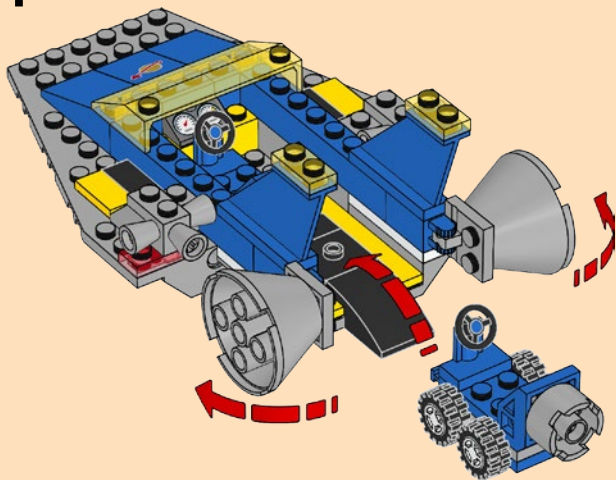

2

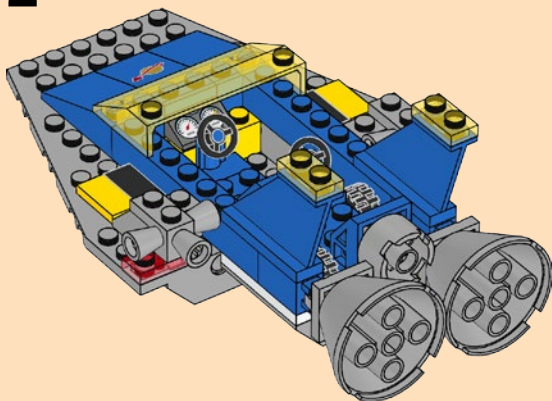

1



2



3





4x
6194809



1x
4216652



1x
4520636



1x
302101



2x
371001



1x
306221



1x
614321



1x
6127728



1x
300421



1x
6126048



1x
4619543



2x
371021



1x
306223



1x
6250980



1x
6252526



1x
9341



1x
6179330



2x
6131690



1x
6254759



2x
4657998



1x
302023



2x
6254675



1x
6254680



2x
6254953

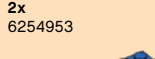

2x
300823



2x
9566



1x
6254733



1x
6250710



1x
9553



2x
306924



1x
407924



3x
300224

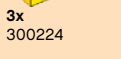

2x
663624



4x
4578677



2x
249626



3x
306926



1x
4565323



1x
6147790



4x
4619323



2x
4516196



2x
6172283



2x
6240212



2x
6240211



1x
6250952



1x
4251378

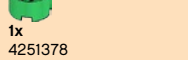

1x
4509897



1x
6023257



1x
6030875



1x
6254955



1x
6249237



1x
6253460



1x
6250965

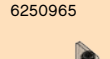

1x
6253360

1x
6253360

4x
4620993

1x
6254674

1x
6254674



1x
6254674

1x
6254955

1x
6254955

1x
6249237

1

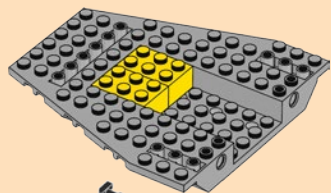

2

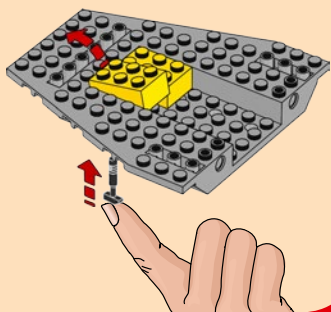

2x
4211503

2x
6152344

1x
6092956

1x
4211526

4x
6015344

2x
4666449

2x
4211410

4x
6109684

2x
4223363

2x
4211504

1x
6133587

2x
6199554

1x
4211395

1x
6254747

1x
6134910



1x
6254686

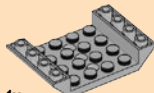

1x
4549997

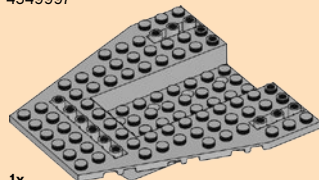

1x
6250322

Customer Service

Kundenservice

Service Consommateurs

Servicio Al Consumidor

LEGO.com/service or dial



: 00800 5346 5555

: 1-800-422-5346

WIN

GO TO WWW.LEGO.COM/PRODUCTFEEDBACK AND
GIVE US YOUR SHORT **FEEDBACK** ABOUT THIS
LEGO® SET FOR A CHANCE TO WIN
A COOL LEGO PRIZE.

Terms & Conditions apply

LEGO.com/productfeedback



GEWINNE

Erzähle uns auf
www.LEGO.com/productfeedback

etwas über die Erfahrungen, die du mit
diesem LEGO® Set gemacht hast, und
sichere dir die Chance auf einen coolen
LEGO Preis!

Es gelten die Teilnahmebedingungen

GAGNE

Rends-toi sur
www.LEGO.com/productfeedback

et donne-nous quelques commentaires sur
ce produit LEGO® pour avoir une chance
de gagner un prix LEGO !

Voir Conditions Générales

GANAN

Visita
www.LEGO.com/productfeedback

y envíanos tu opinión acerca de este set
LEGO®. ¡Participarás en el sorteo de un
premio LEGO!

Términos y Condiciones aplicables

获取奖品

登录
www.LEGO.com/productfeedback

给出关于此乐高®套装的简短反馈，
就有机会获得炫酷乐高高奖品

《条款及条件》适用

THE LEGO® MOVIE 2™ © & ™, Warner Bros. Entertainment Inc. & The LEGO Group. LEGO, the LEGO logo, DUPLO, the Minifigure and the Brick and Knob configurations are trademarks and/or copyrights of the LEGO Group. ©2019 The LEGO Group. All rights reserved. WB SHIELD: TM & © WBEI. (s19)



6270736